

EXPERT 34 E > 18CWF1S-C50 (2016) > HECKKLAPPE, MÄHWERKSGEHÄUSE, MULCHKLAPPE

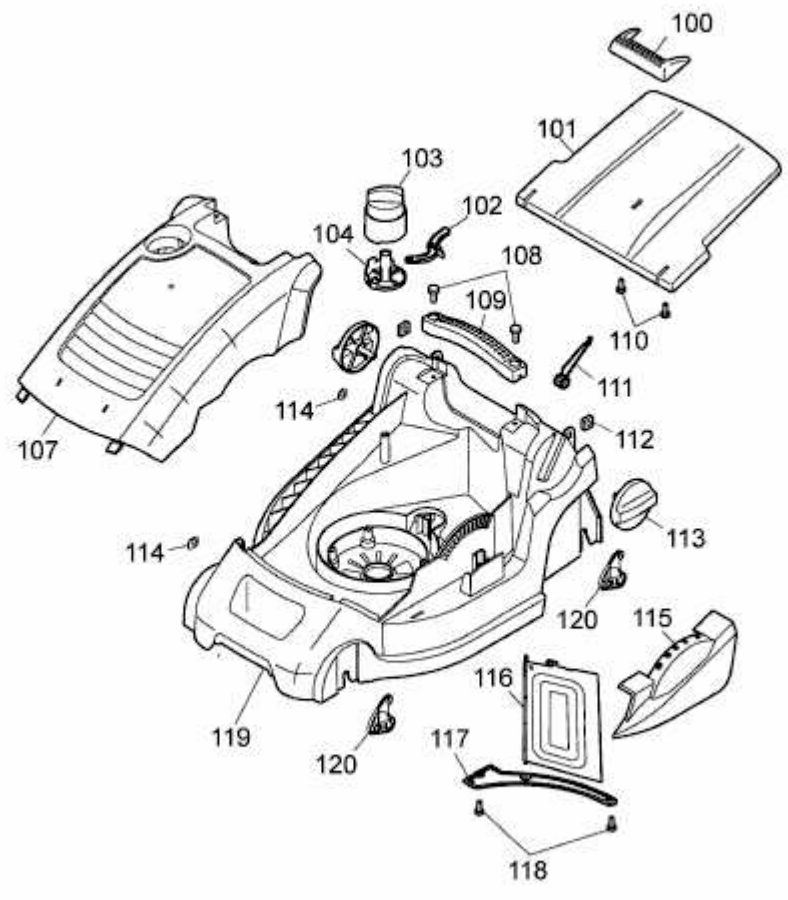

E3-08786A-01