

FF 307-1 > 18CKB0C2634 (2009) > GRUNDGERÄT

JUNIOR 31	18C-D0D2600	MZ/X 32	18C-B0D-665
BG 1000	18C-D0D2625	BRONTO 1000W	18C-B0D-R02
BG 1000	18C-D0D-625	FF 307-1	18C-B0D-634
FF 317	18C-D0D-665	FF 307-1	18CKB0C2634

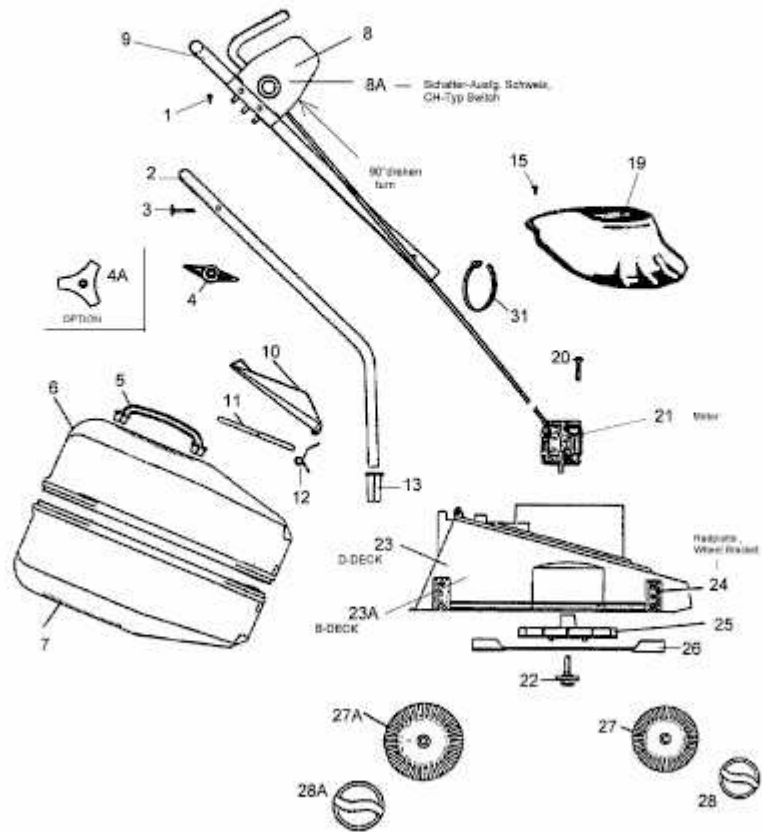

E3-03950A-01