

FF 3772 > 18C-F0J-665 (2007) > GRUNDGERÄT

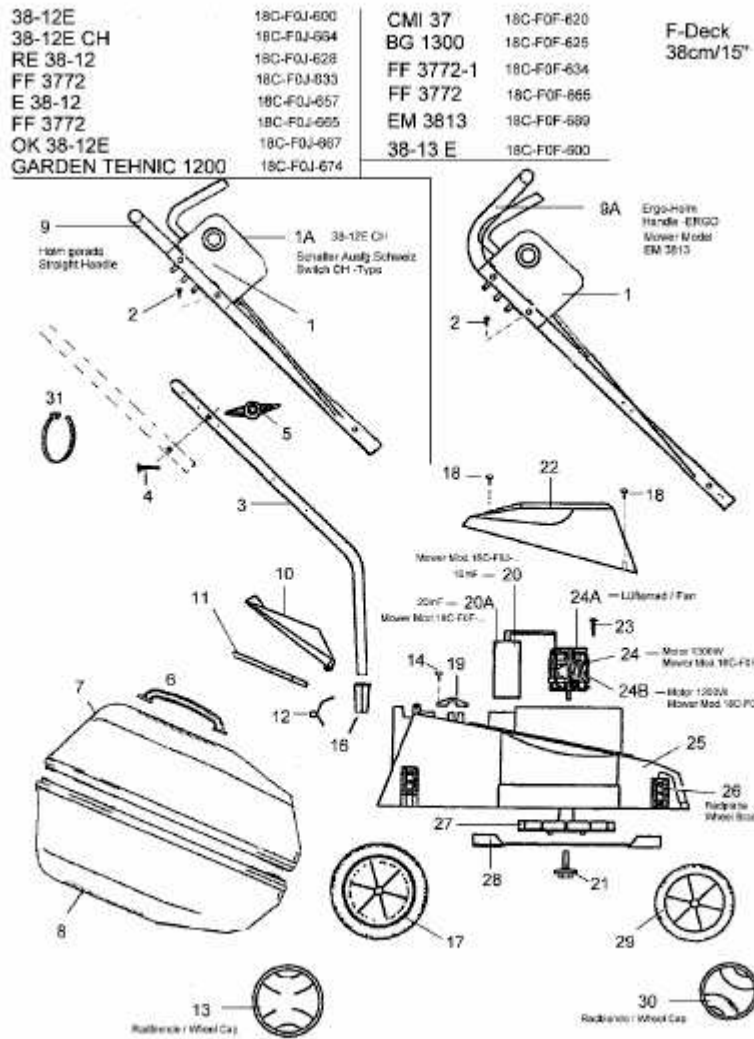

E3-01999A-01