

FF 3772 > 18C-F0F-665 (2008) > GRUNDGERÄT

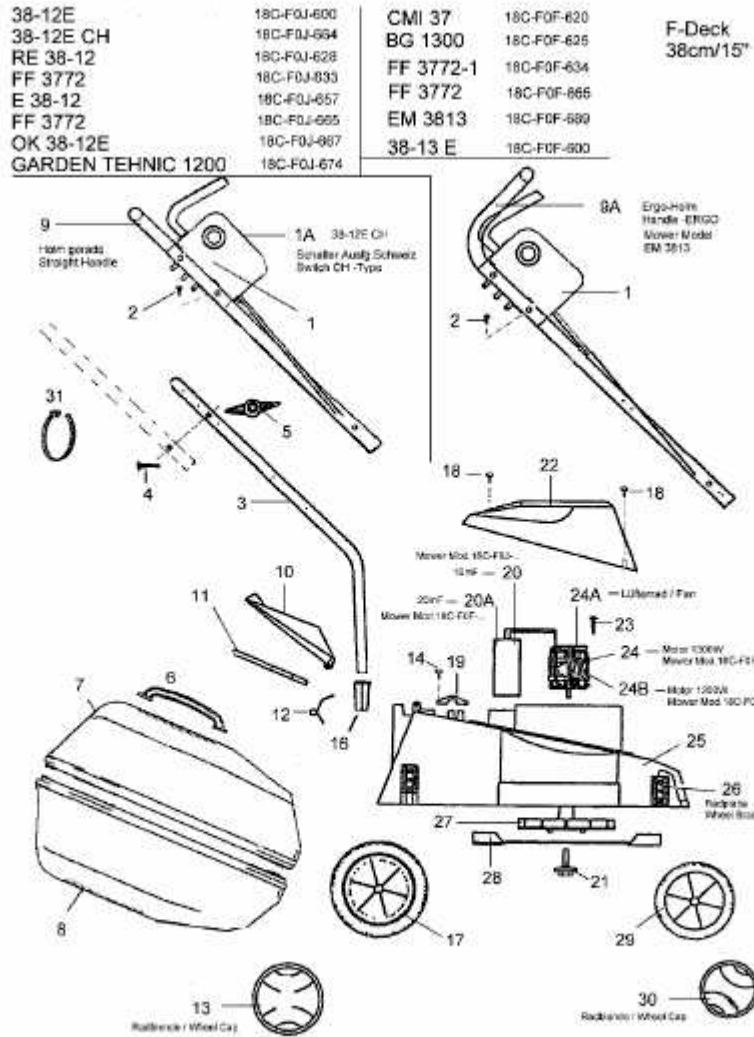

E3-01999A-01