

FF 3772-1 > 18C-F0F-634 (2006) > GRUNDGERÄT

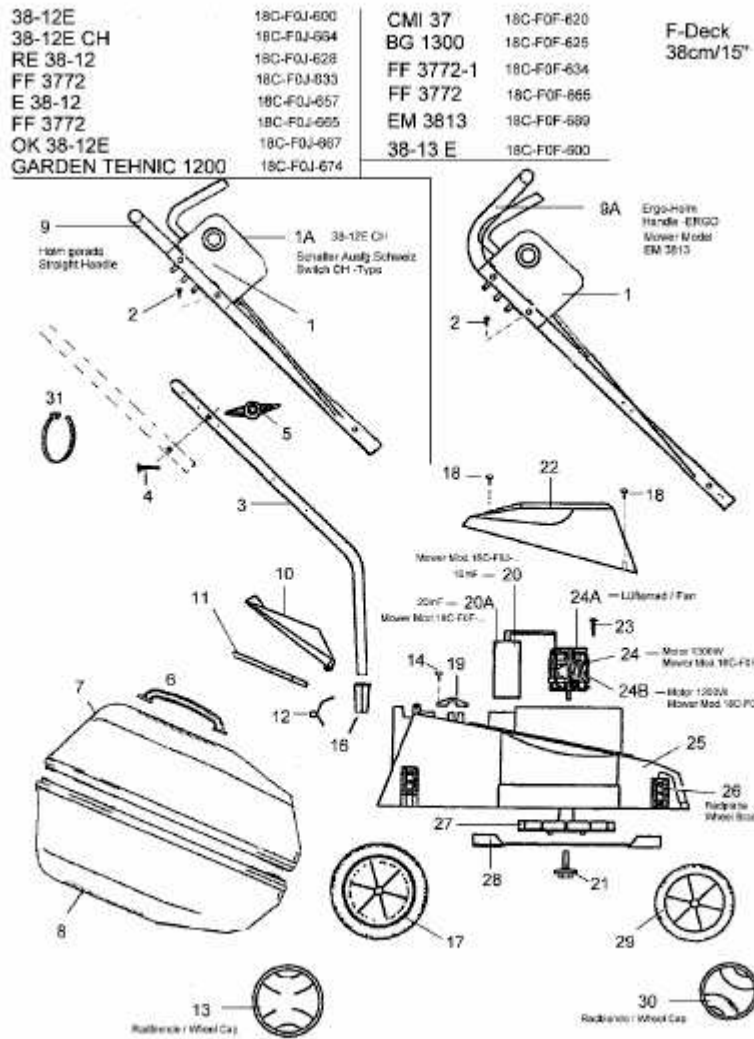

E3-01999A-01