

EXPERT 37 E > 18BWG1H-C50 (2014) > MÄHWERKSGEHÄUSE

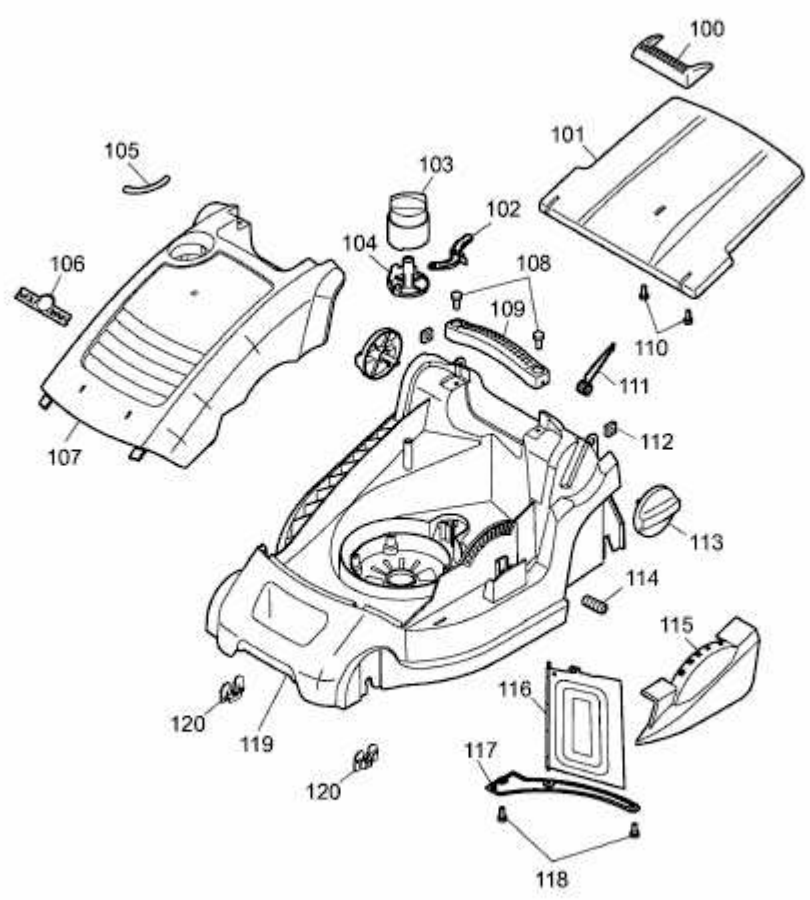

E3-06052A-01