

EXPERT 34 E > 18BWF1S-650 (2016) > HECKKLAPPE, MÄHWERKSGEHÄUSE, MULCHKLAPPE

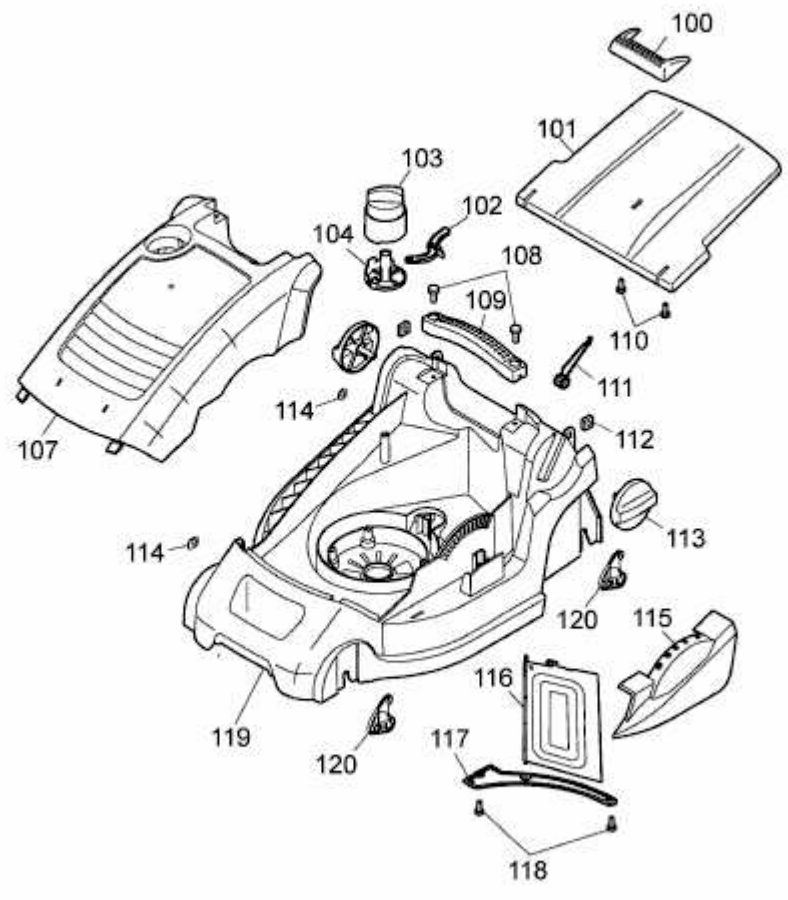

E3-08786A-01