

AMBITION 38 E > 18BCH4H2650 (2014) > GRUNDGERÄT

AMBITION 38 E  
18BCH4H2650

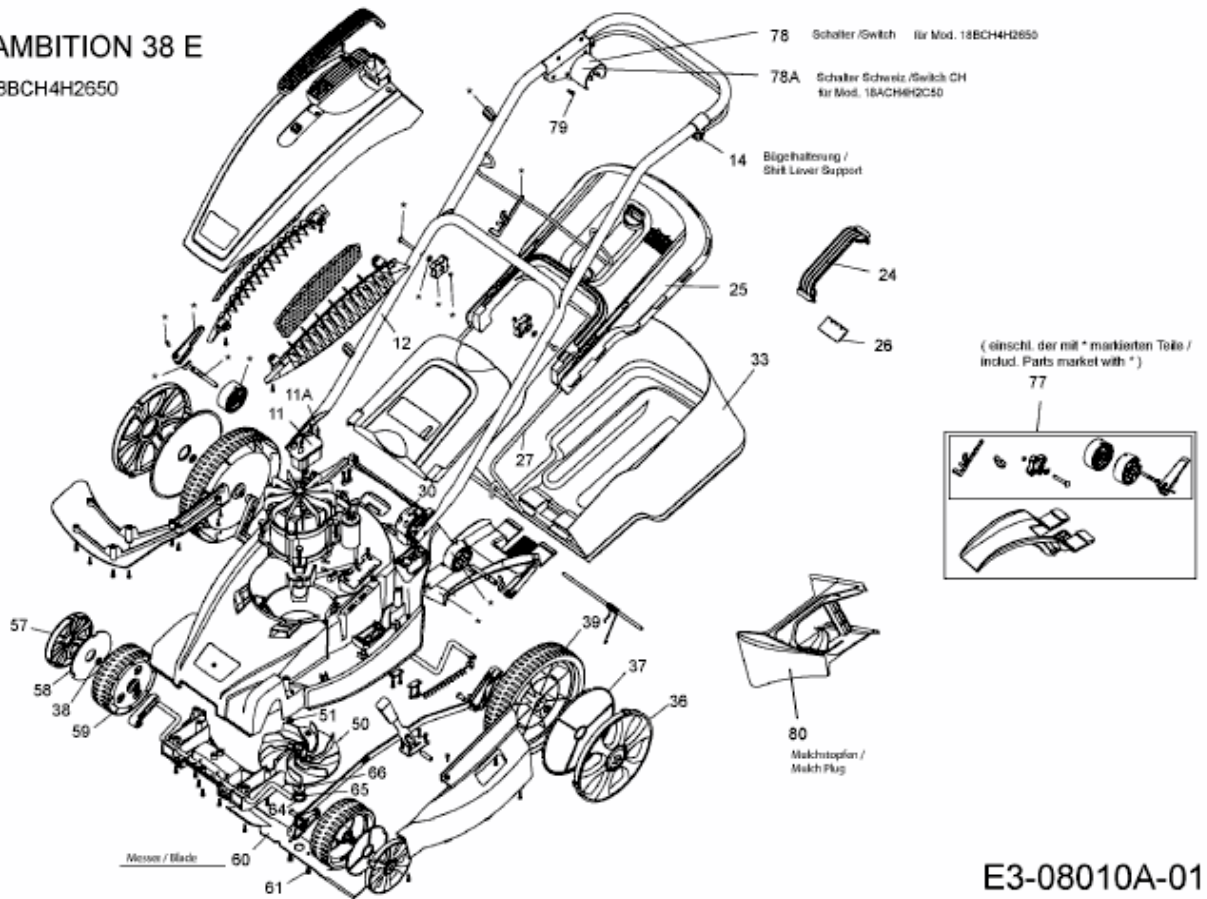

E3-08010A-01