

E 451 > 18B-T2H-619 (2000) > GRASFANGKORB, HOLM

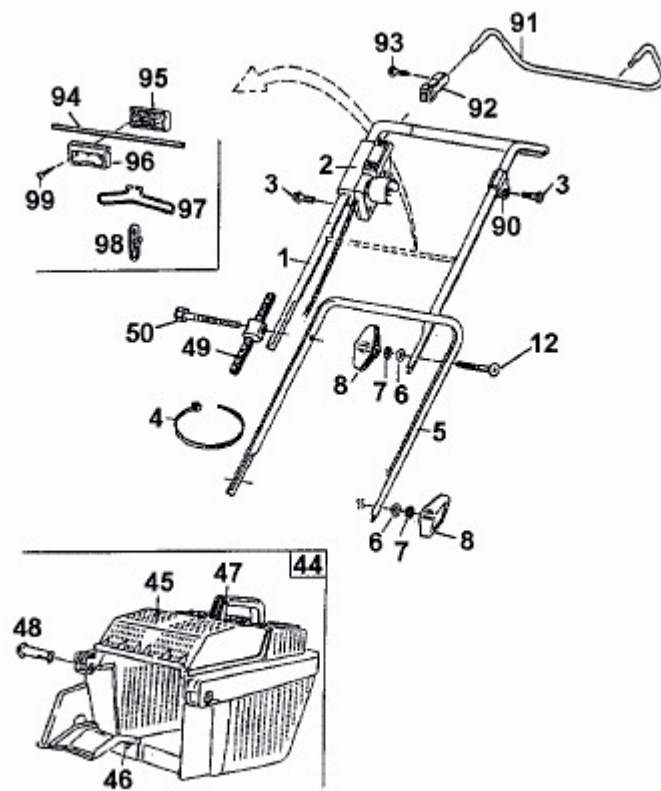

fsg