

E 381 > 18B-G2F-619 (2002) > GRUNDGERÄT

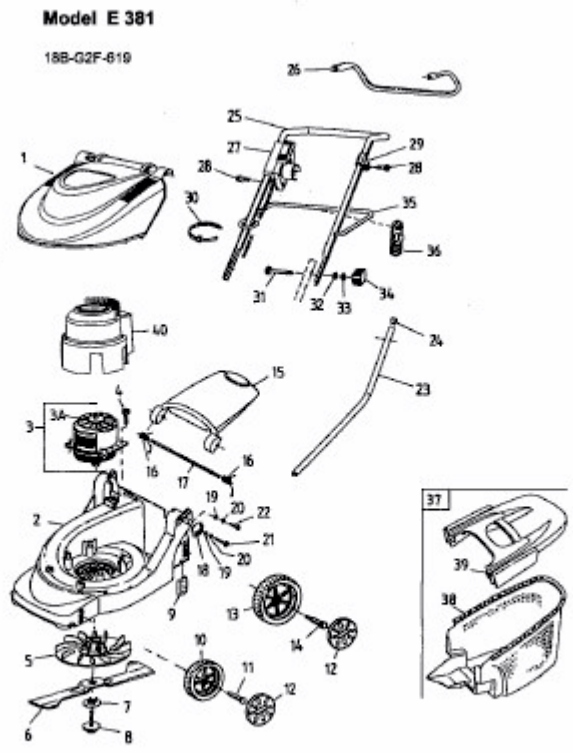

E3-01470A