

E 1800-48 HMA > 18AR11K-C94 (2010) > GRASFANGSACK, HECKKLAPPE

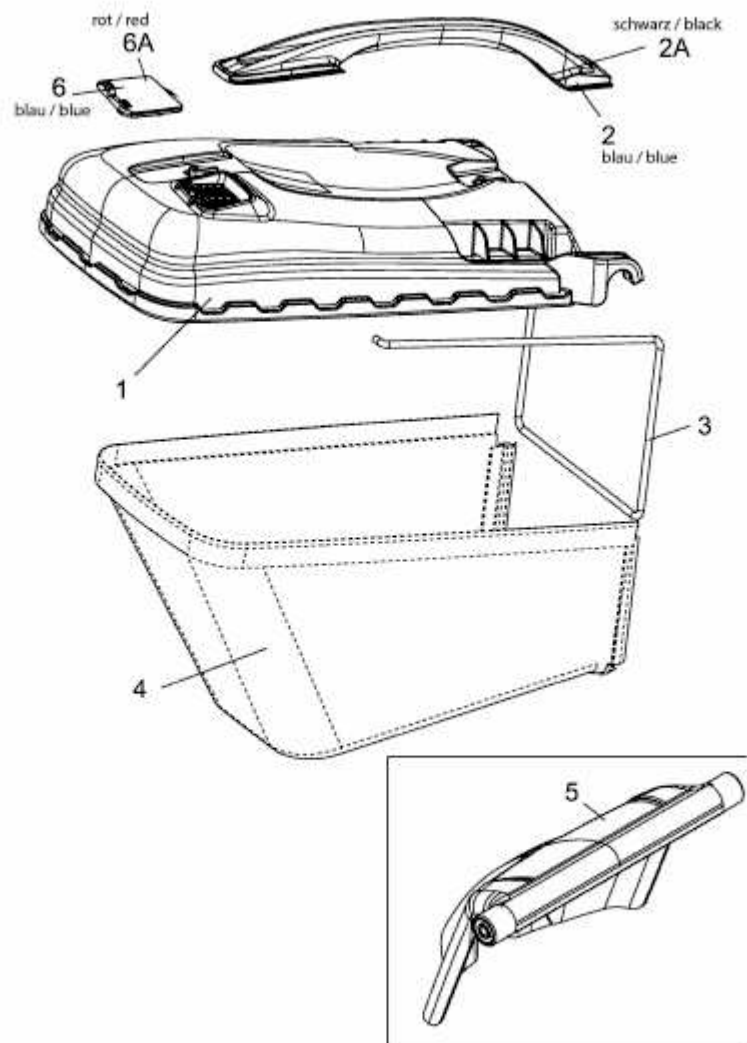

E3-05364A-01