

AMBITION 42 E > 18ACI4L2C50 (2011) > GRUNDGERÄT

AMBITION 42 E
18ACI4L2650
18ACI4L2C50

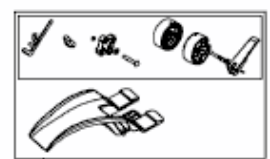
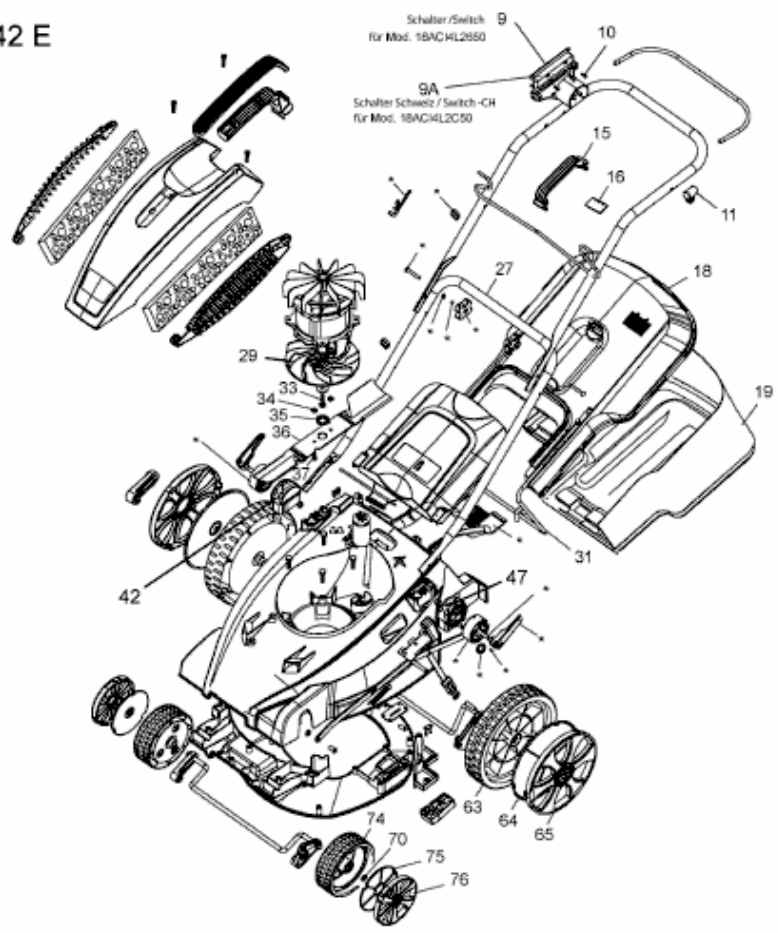

77
(einschl. der mit * markierten Teile /
includ. Parts marked with *)

E3-06689A-01