

AMBITION 42 E > 18ACI4L2650 (2012) > GRUNDGERÄT

AMBITION 42 E

18ACI4L2650
18ACI4L2C50

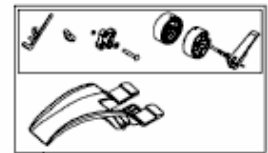
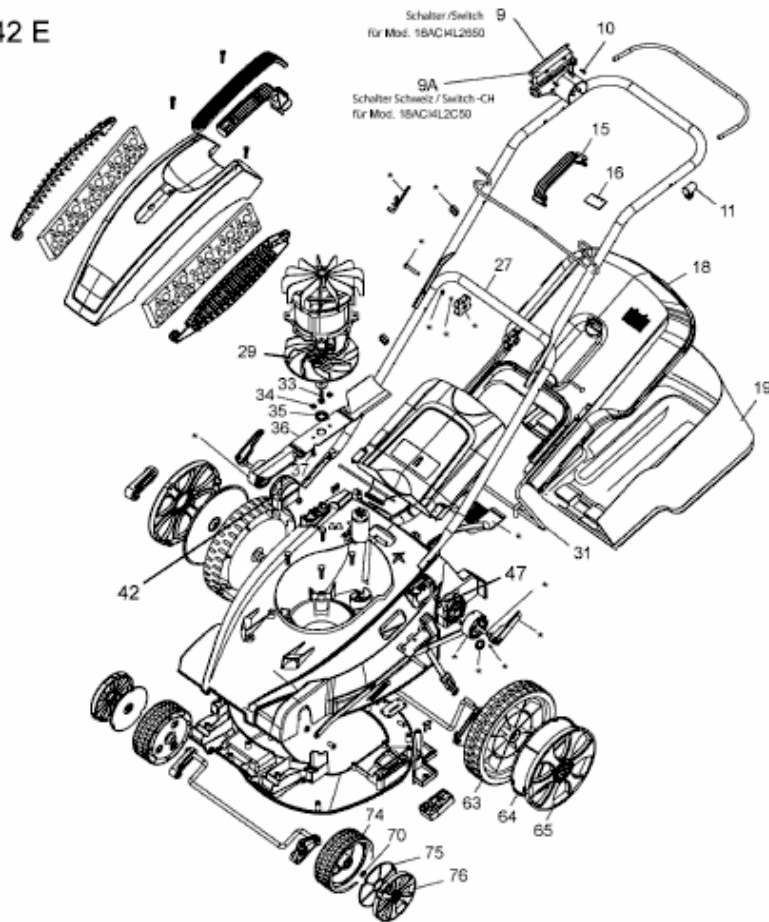

77
(einschl. der mit * markierten Teile /
includ. Parts marked with *)

E3-06689A-01