

AMBITION 38 E > 18ACH4H2650 (2012) > GRUNDGERÄT

AMBITION 38 E

18ACH4H2650
18ACH4H2C50

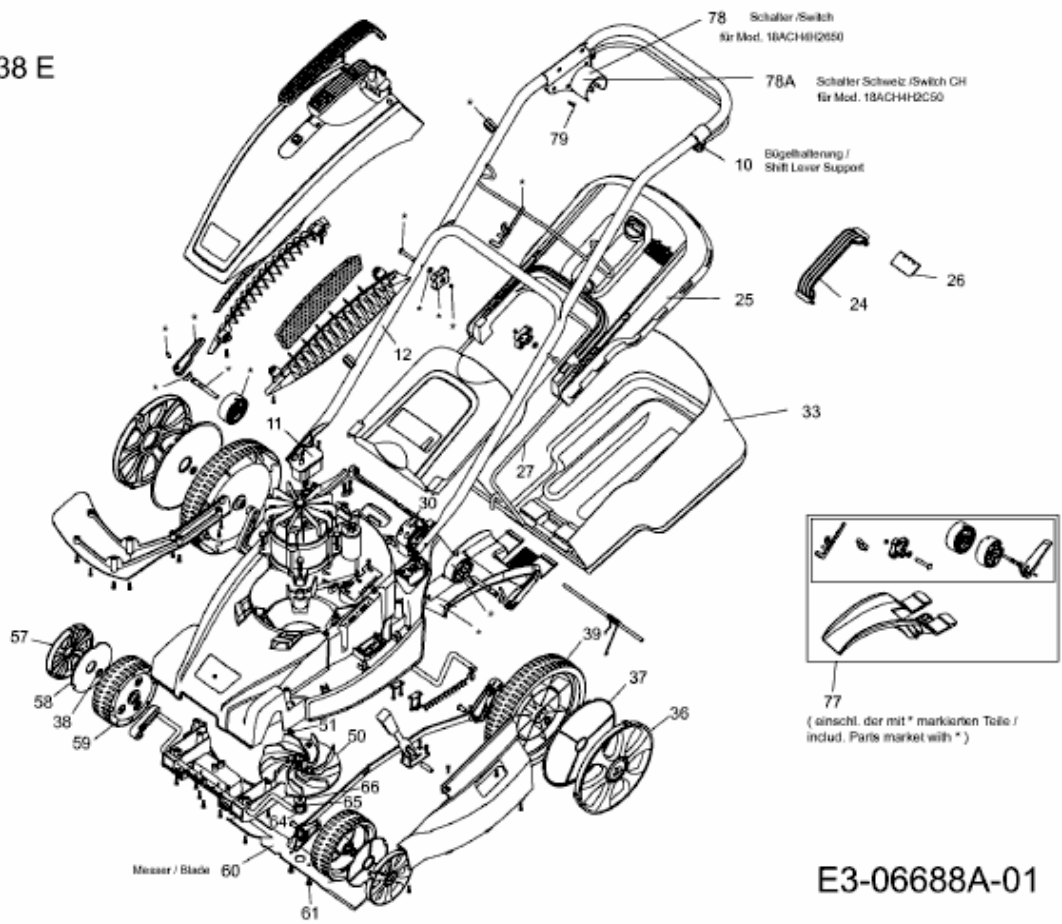

E3-06688A-01