

YM 1719 E > 18A-18K-643 (2011) > RADKAPPEN

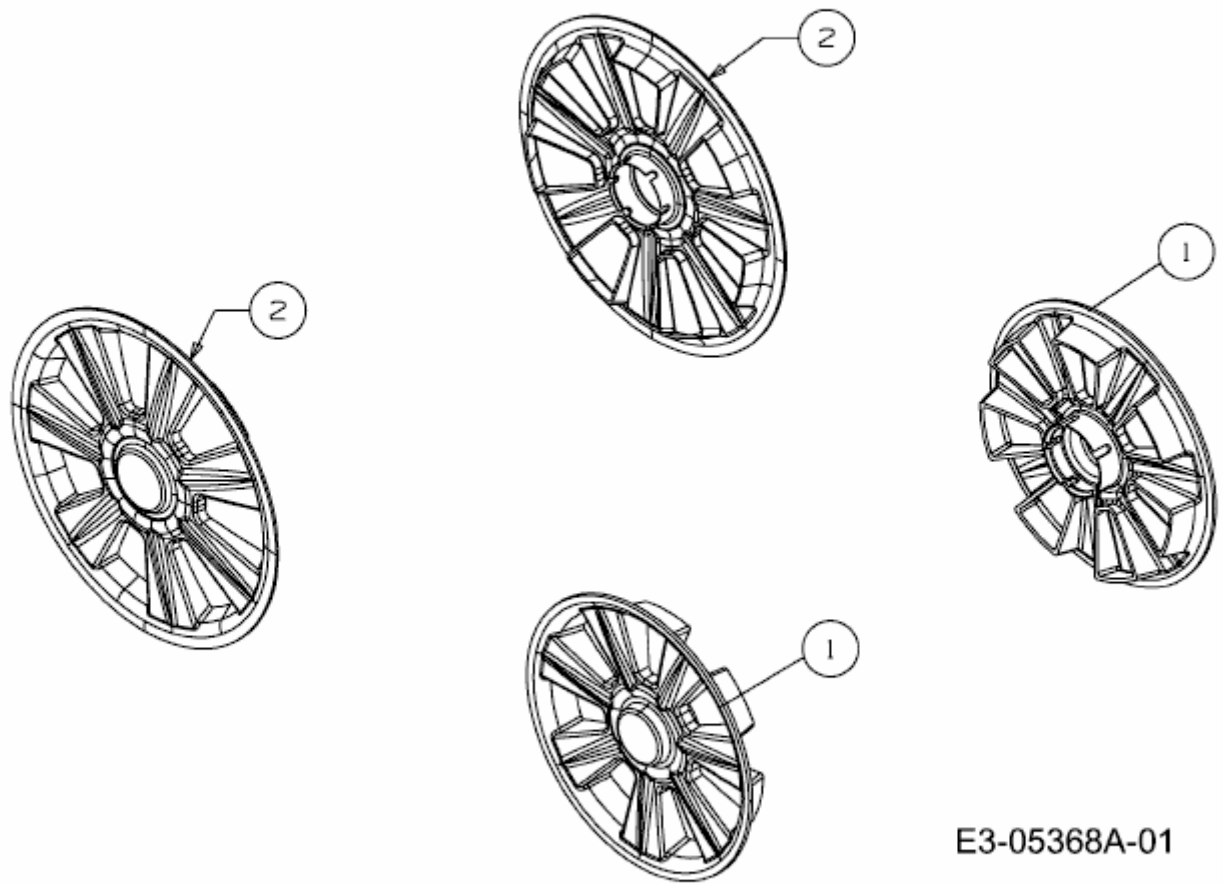

E3-05368A-01