

YM 1719 E > 18A-18K-643 (2011) > GRASFANGSACK, HECKKLAPPE

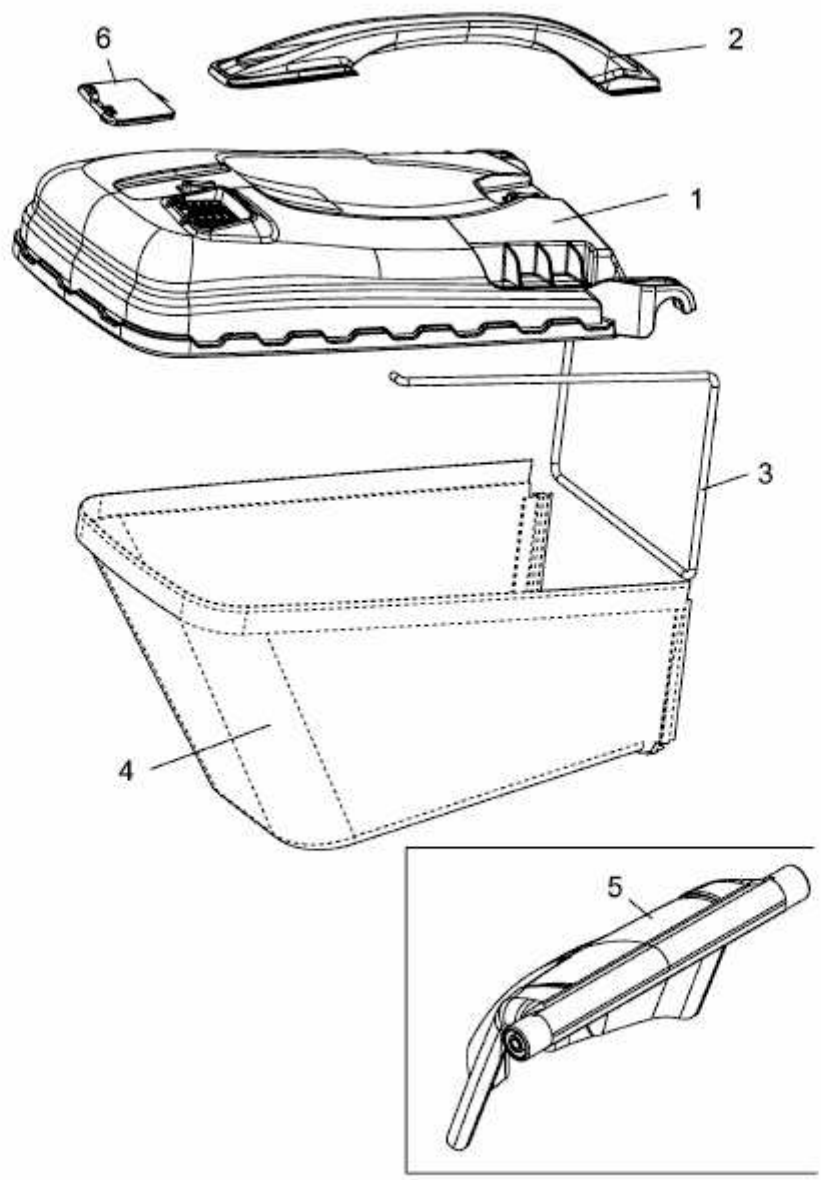

E3-05362A-01