

YM 1719 E > 18A-18K-643 (2008) > BEDIENKONSOLE

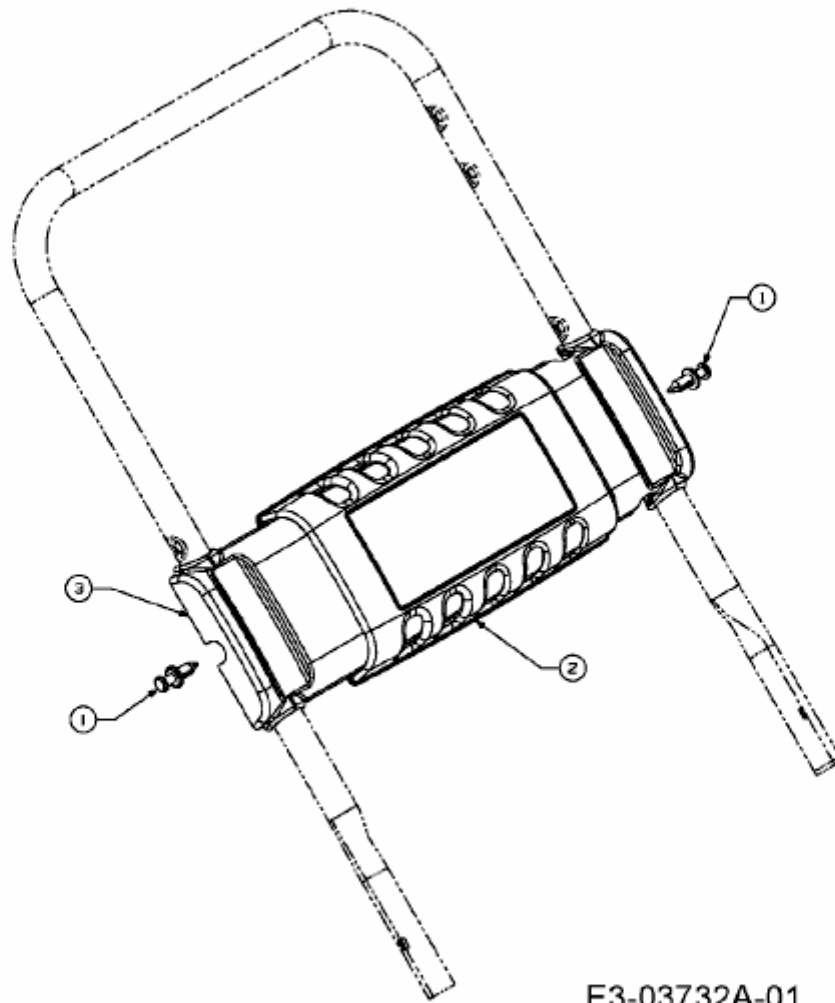

E3-03732A-01