

RZT 50 > 17YF2ACP010 (2015) > ELEKTROTEILE

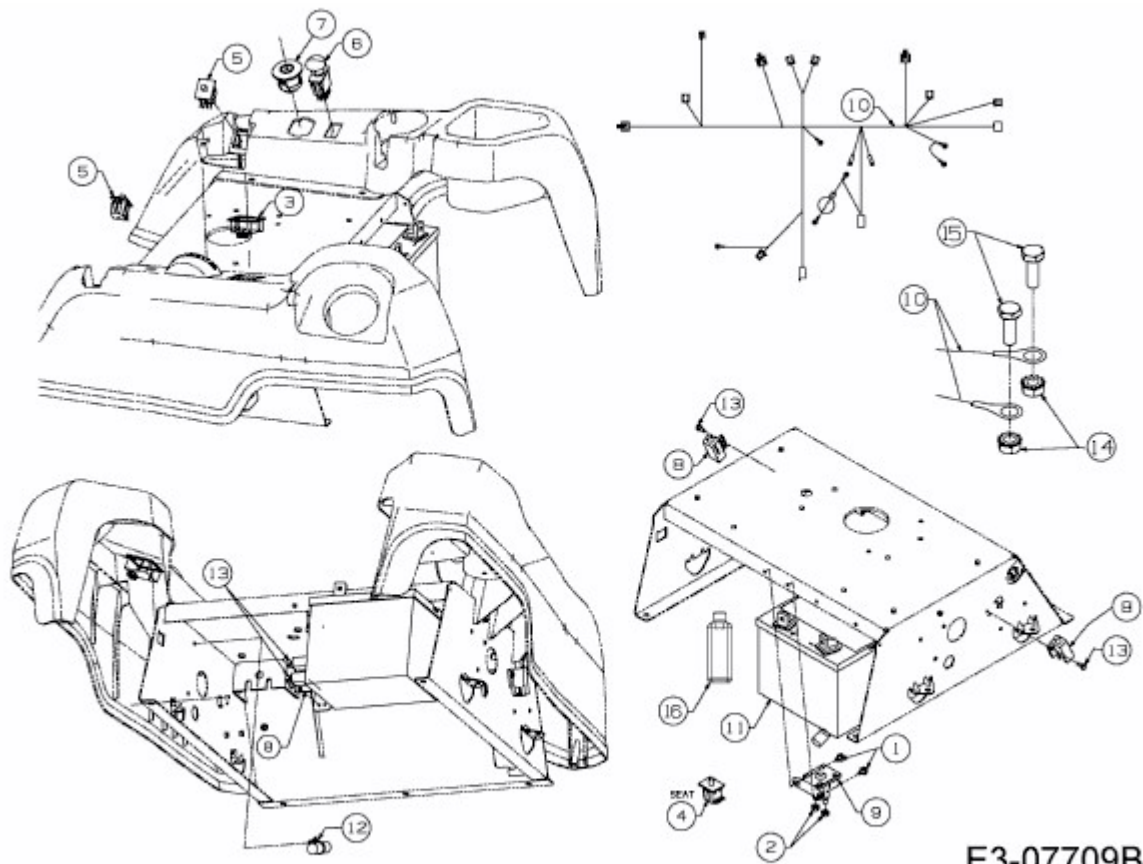

E3-07709B-01