

RZT 50 > 17YF2ACP010 (2015) > SPANNROLLEN FAHRANTRIEB

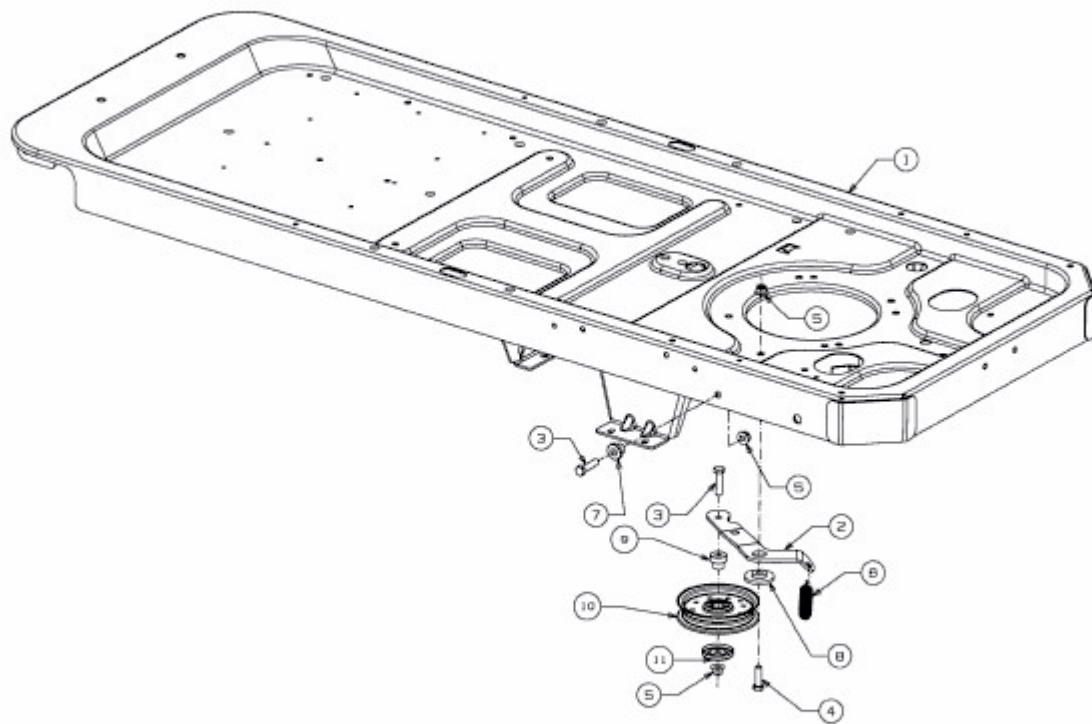

E3-04183E-01