

FMZ 48 > 17BI4BFY603 (2013) > SCHALTPLAN

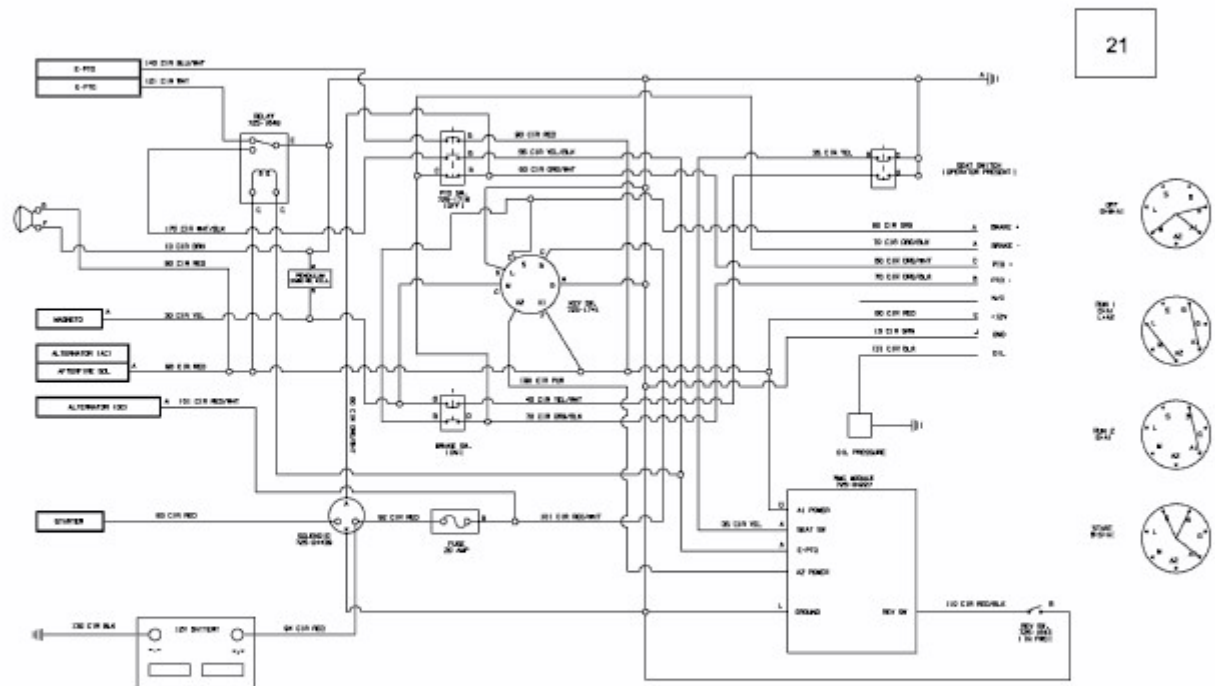

E3-04665B-02