

Z-FORCE SZ 48 > 17AIDGHB603 (2016) > CHOKE- UND GASZUG, MOTORZUBEHÖR

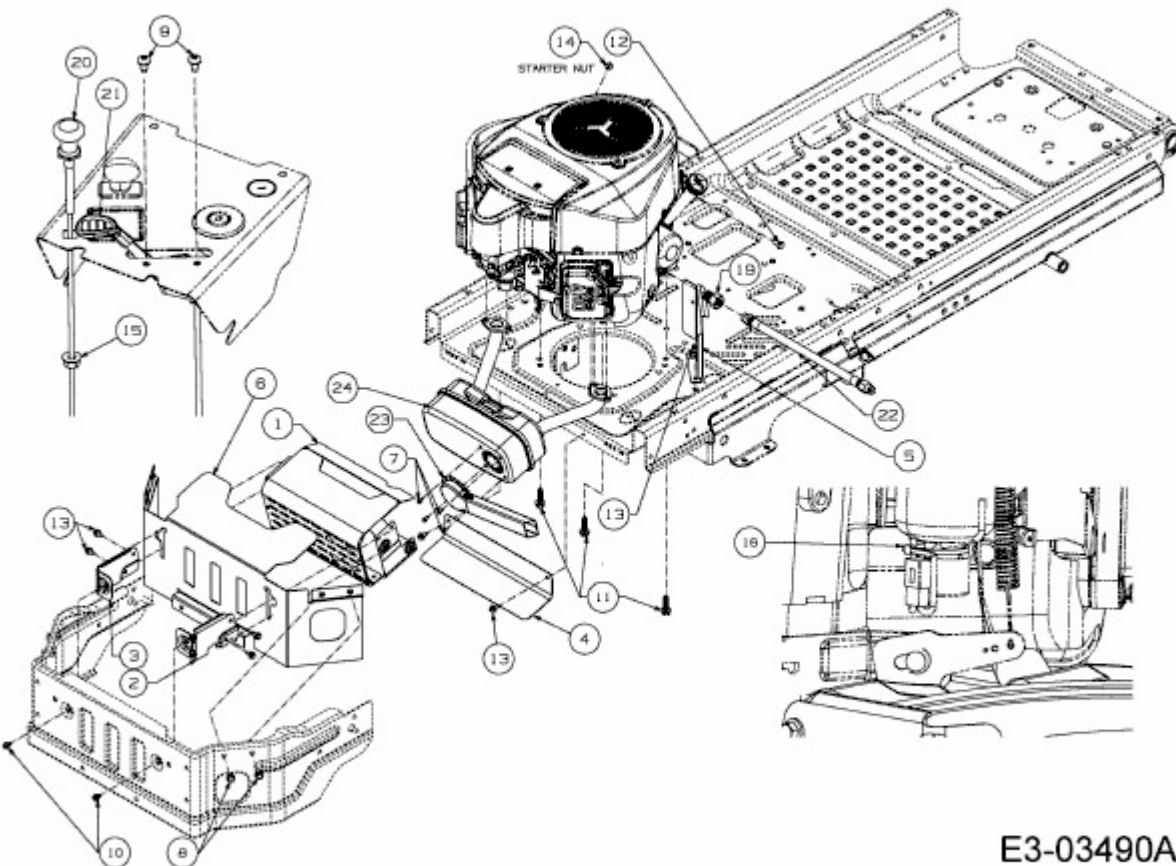

E3-03490A-01