

RZTS 46 > 17AICBDT603 (2014) > CHOKE- UND GASZUG, MOTORZUBEHÖR

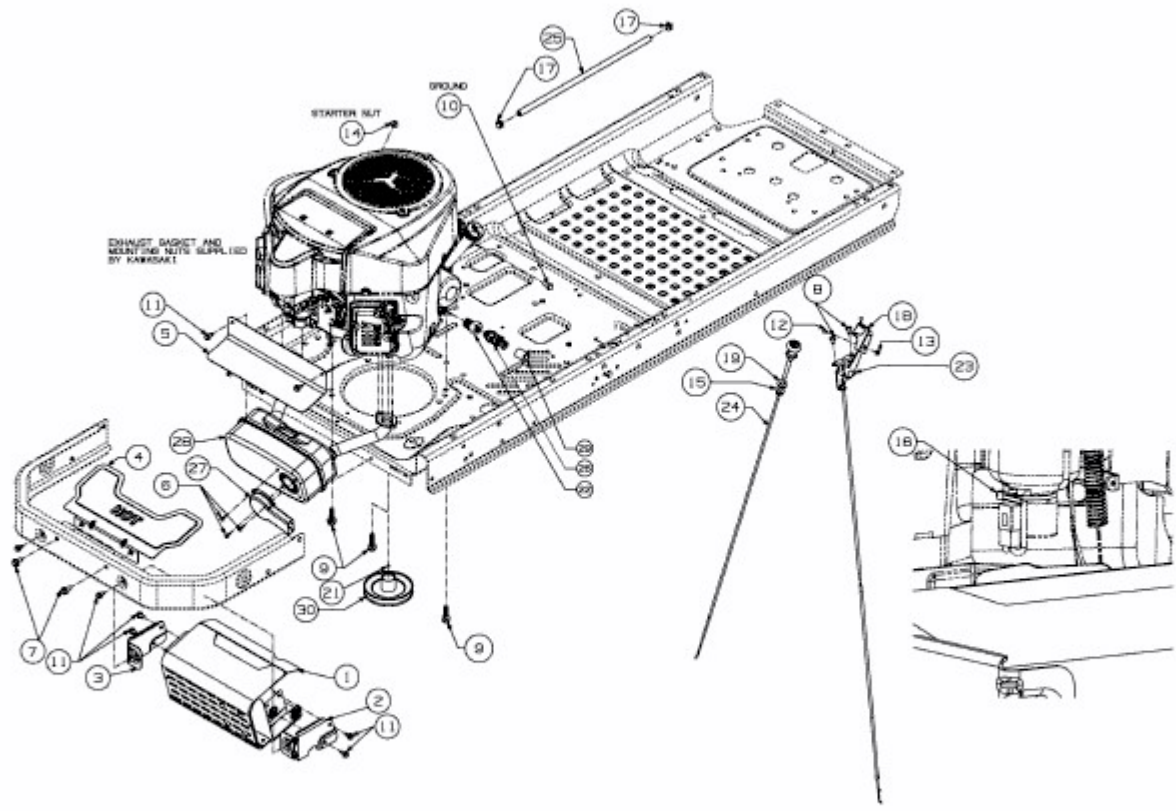

E3-02889A-01