

RZTL 54 > 17AICACK603 (2013) > CHOKE- UND GASZUG, MOTORZUBEHÖR

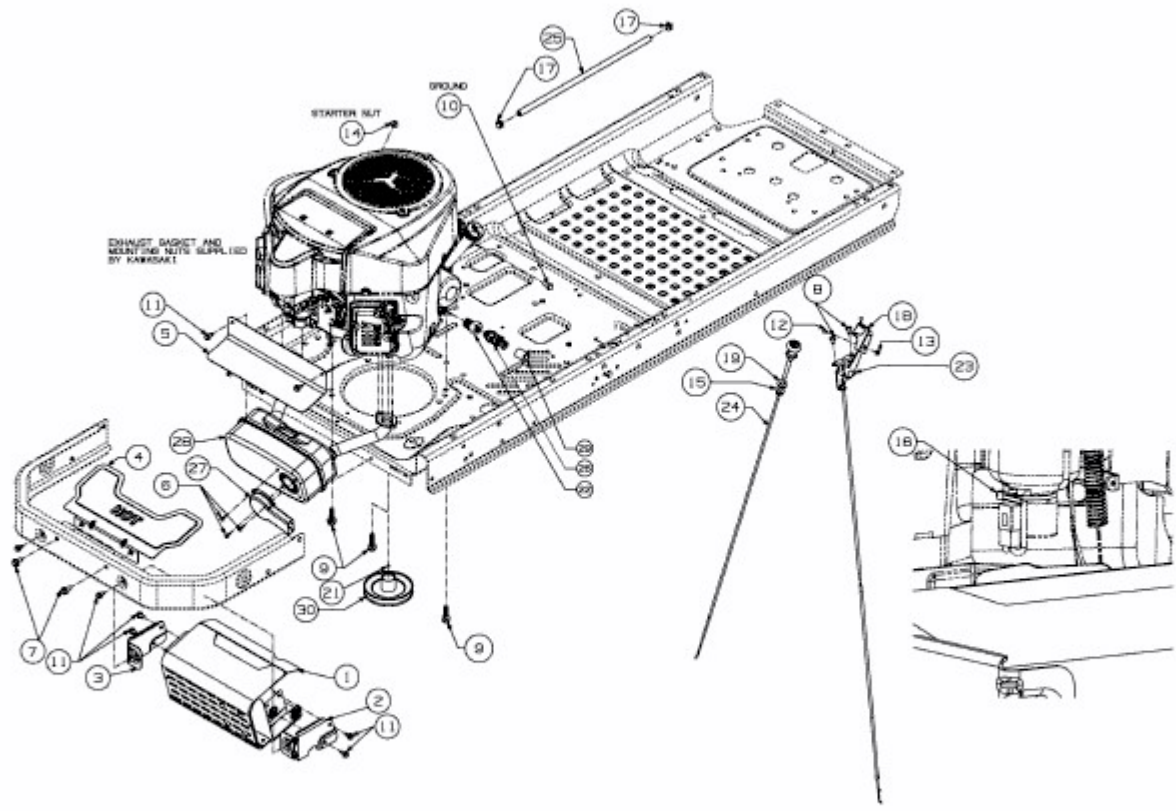

E3-02889A-01