

ALL ROUNDER 1050 > 17A19BKP603 (2013) > ELEKTROMAGNETKUPPLUNG,
MOTORKEILRIEMENSCHLEIBE

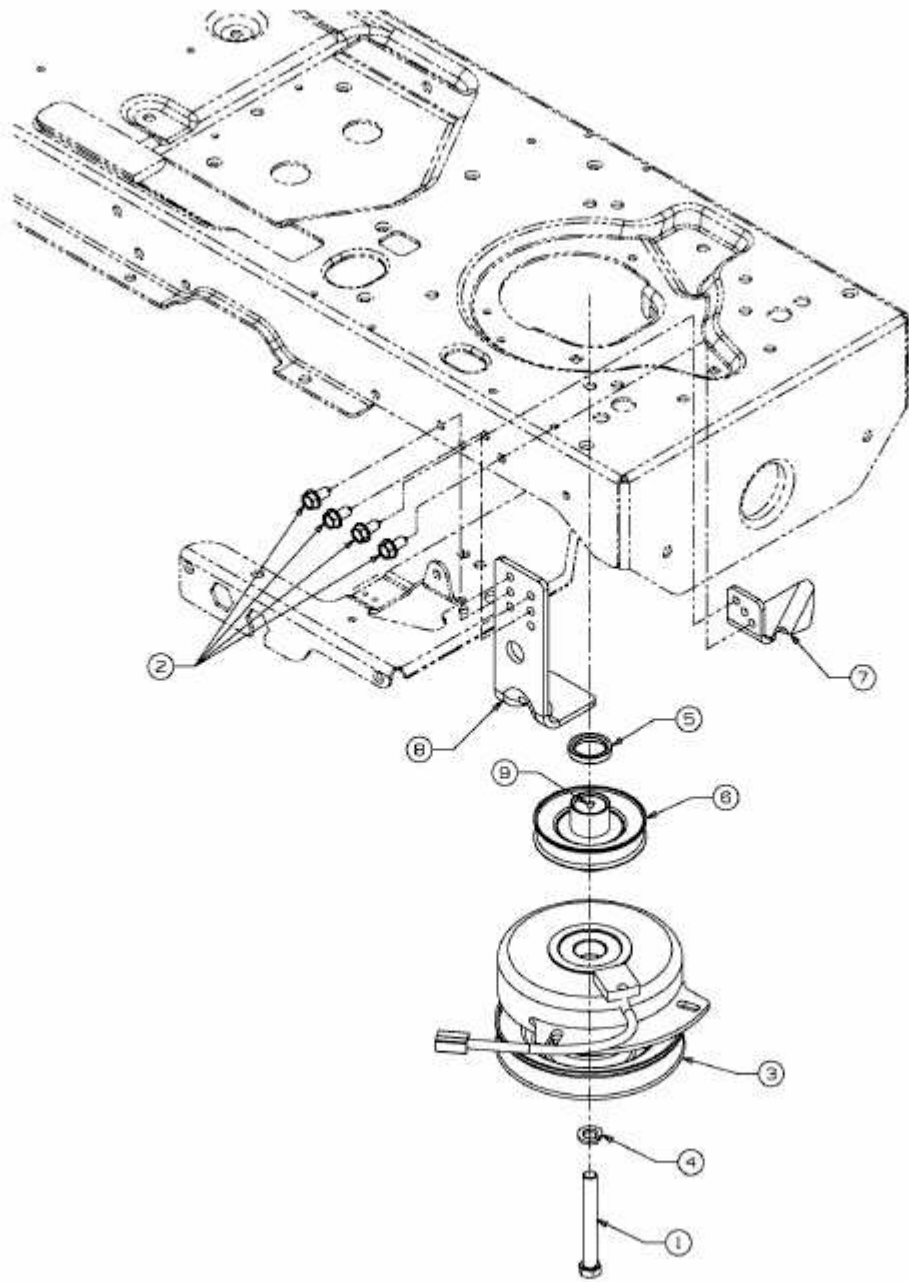

E3-05490A-01