

ab 01.12.2009  
from 01.12.2009  
à partir du 01.12.2009

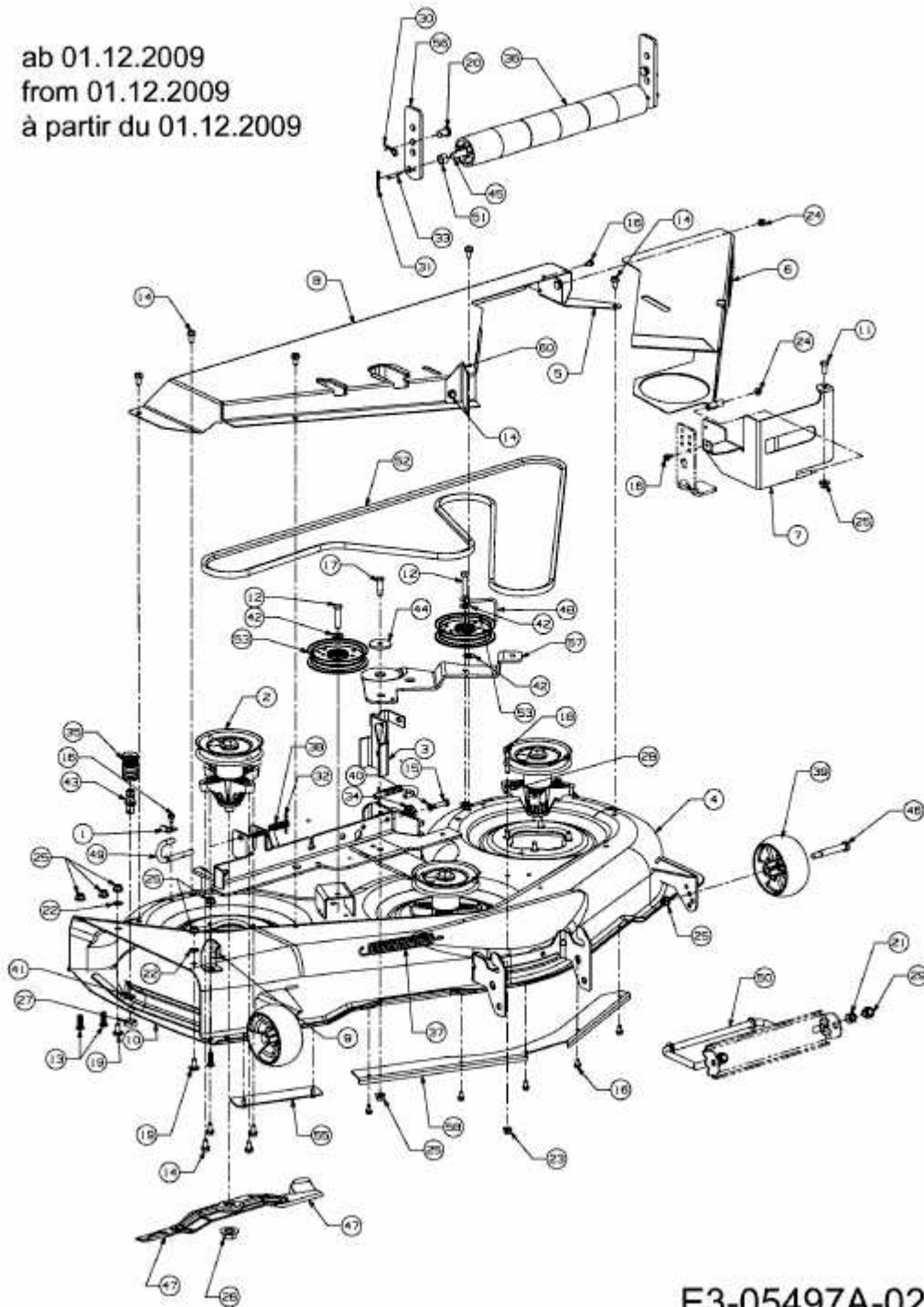

E3-05497A-02