

ALL ROUNDER 1050 > 17A19BKP603 (2010) > ELEKTROMAGNETKUPPLUNG,
MOTORKEILRIEMENSCHIBE

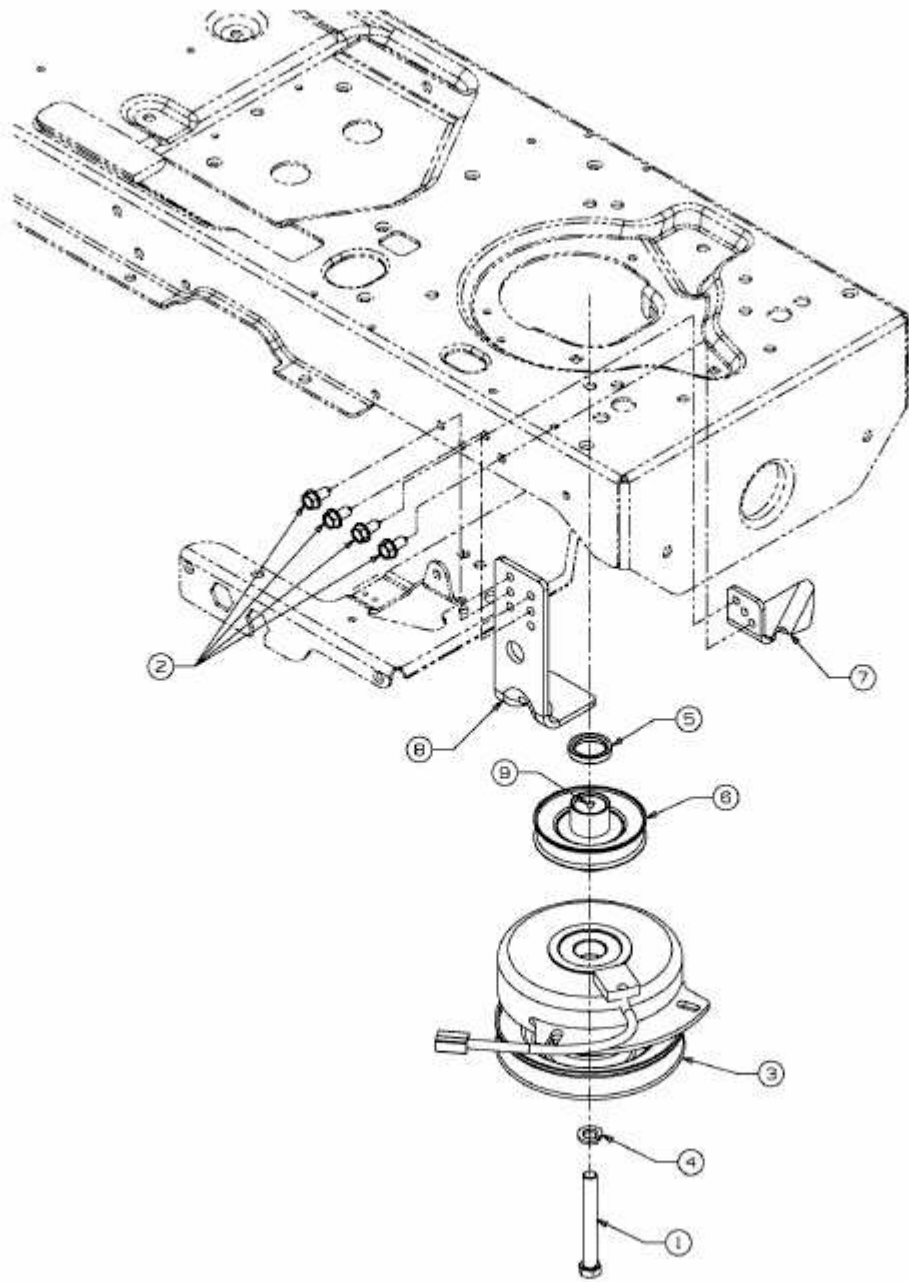

E3-05490A-01