

MF 50-22 FMZ > 17A14BFP695 (2010) > RÄDER 15X6 + 20X10

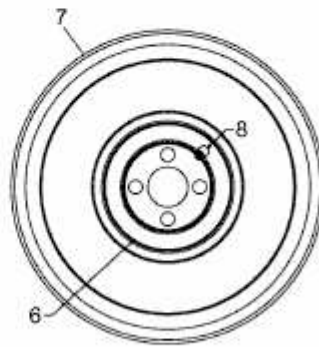
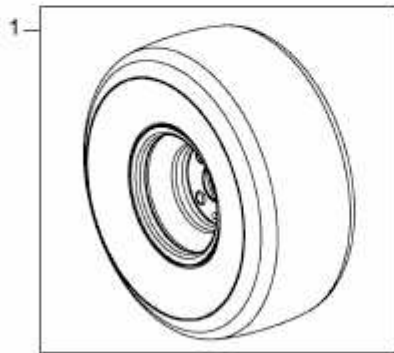
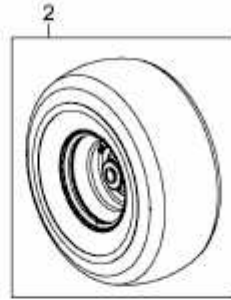
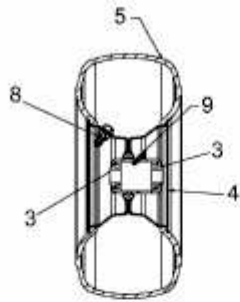

E3-04722A-01