

ab 04.11.2008
from 04.11.2008
à partir du 04.11.2008

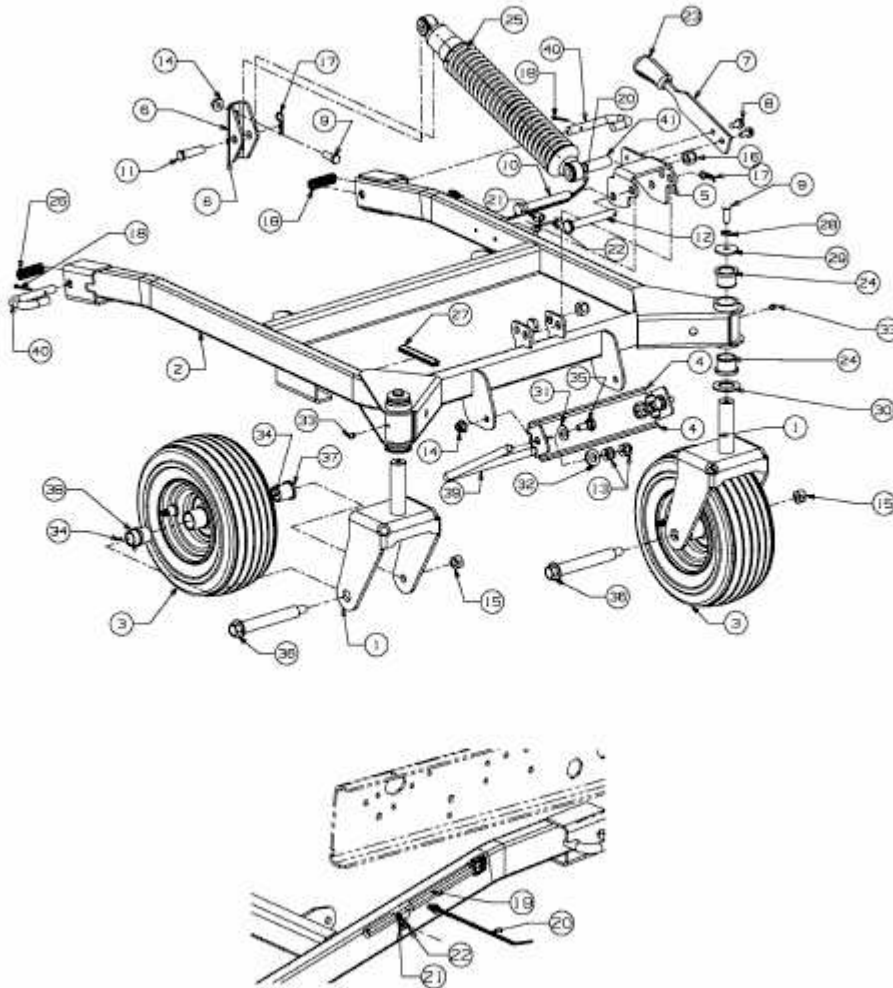

E3-04725A-02