

ab 19.01.2010  
from 19.01.2010  
à partir du 19.01.2010

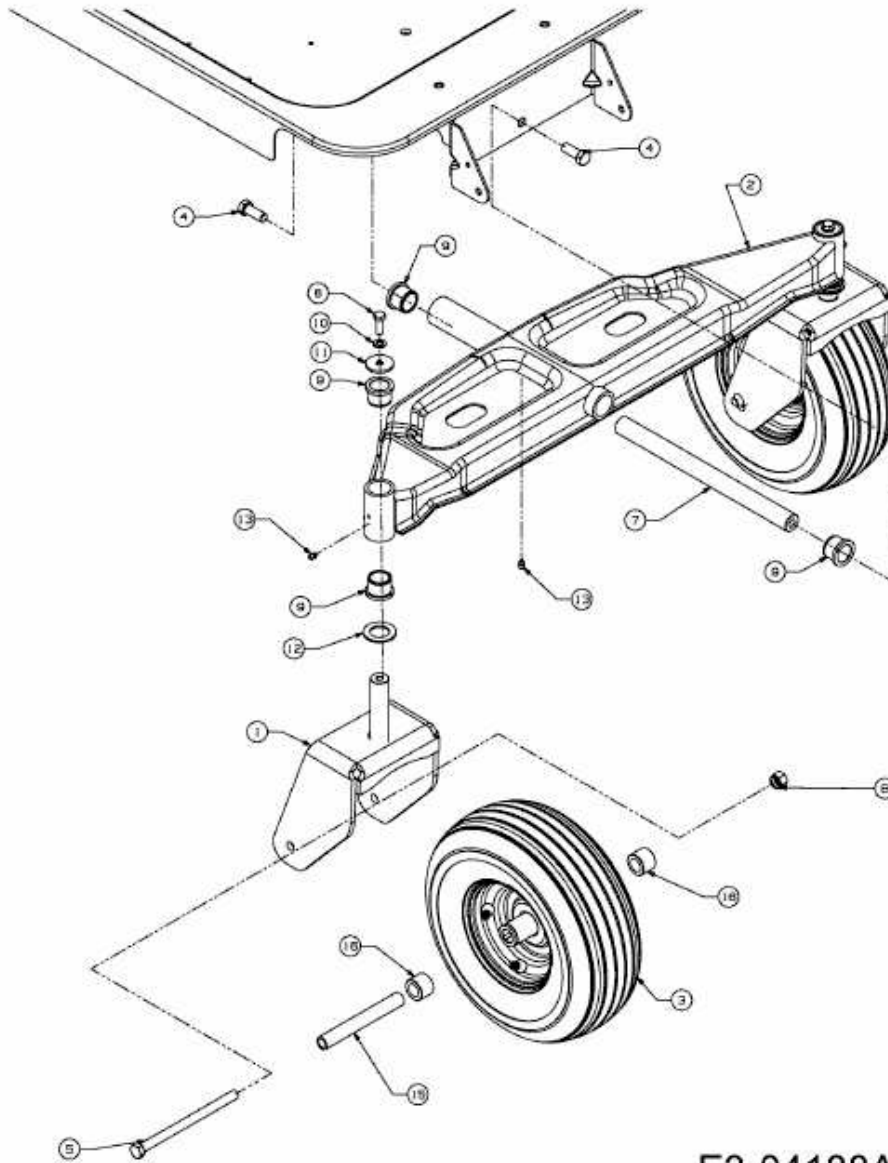

E3-04188A-02