

ab 19.01.2010
from 19.01.2010
à partir du 19.01.2010

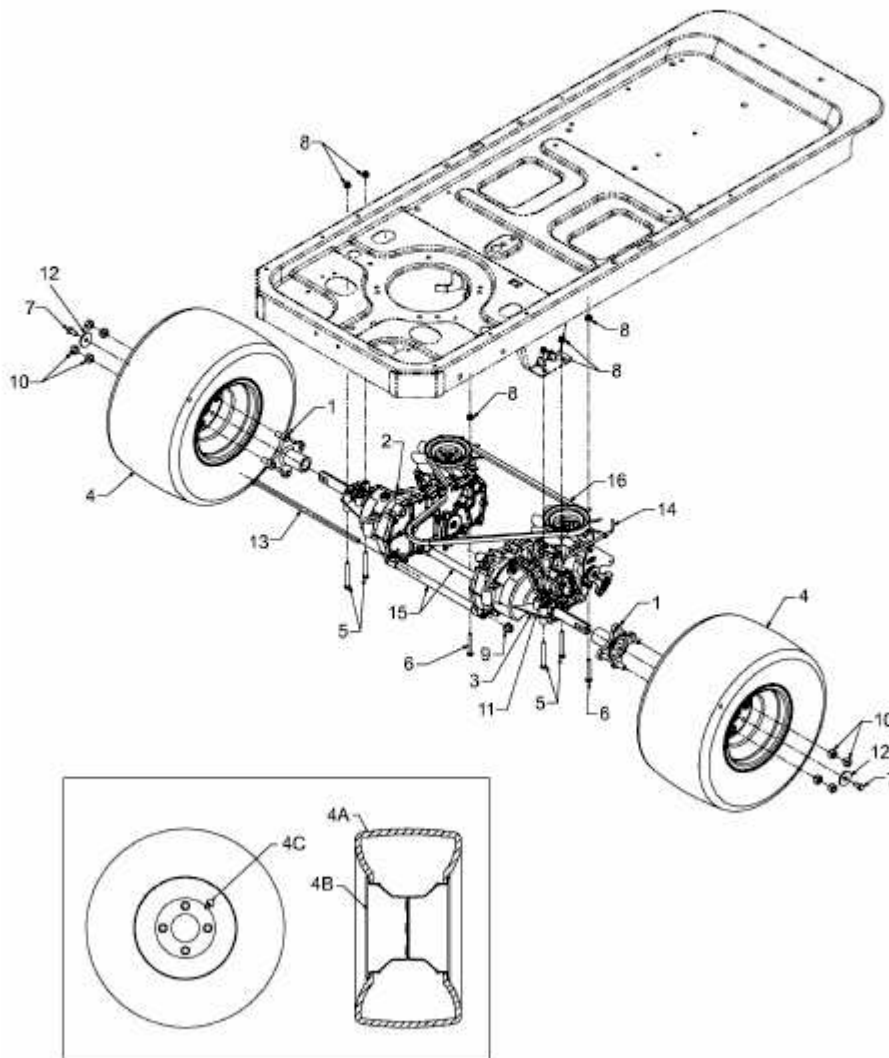

E3-04182B-02