

RZT 50 > 17AI2ACP603 (2011) > RAHMEN, SPANNROLLE FAHRANTRIEB

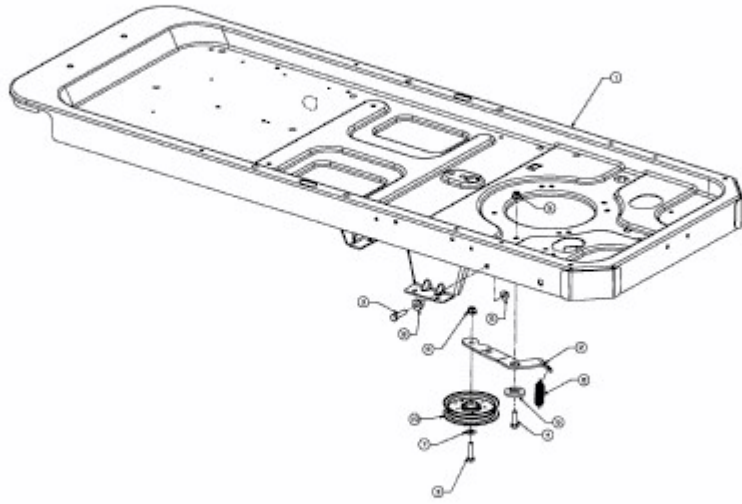

E3-04183B-01