

ab 02.11.2007
from 02.11.2007
à partir du 02.11.2007

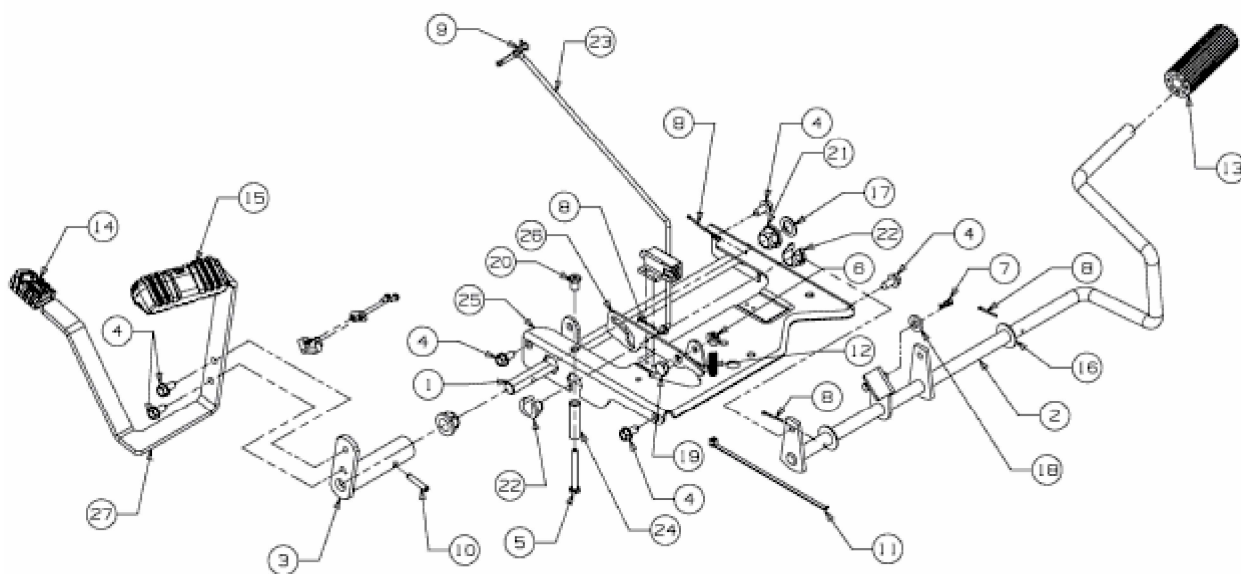

E3-03188B-01