

ALL ROUNDER 1050 > 17AH9BKP603 (2009) > ELEKTROMAGNETKUPPLUNG,
MOTORKEILRIEMENSCHIBE

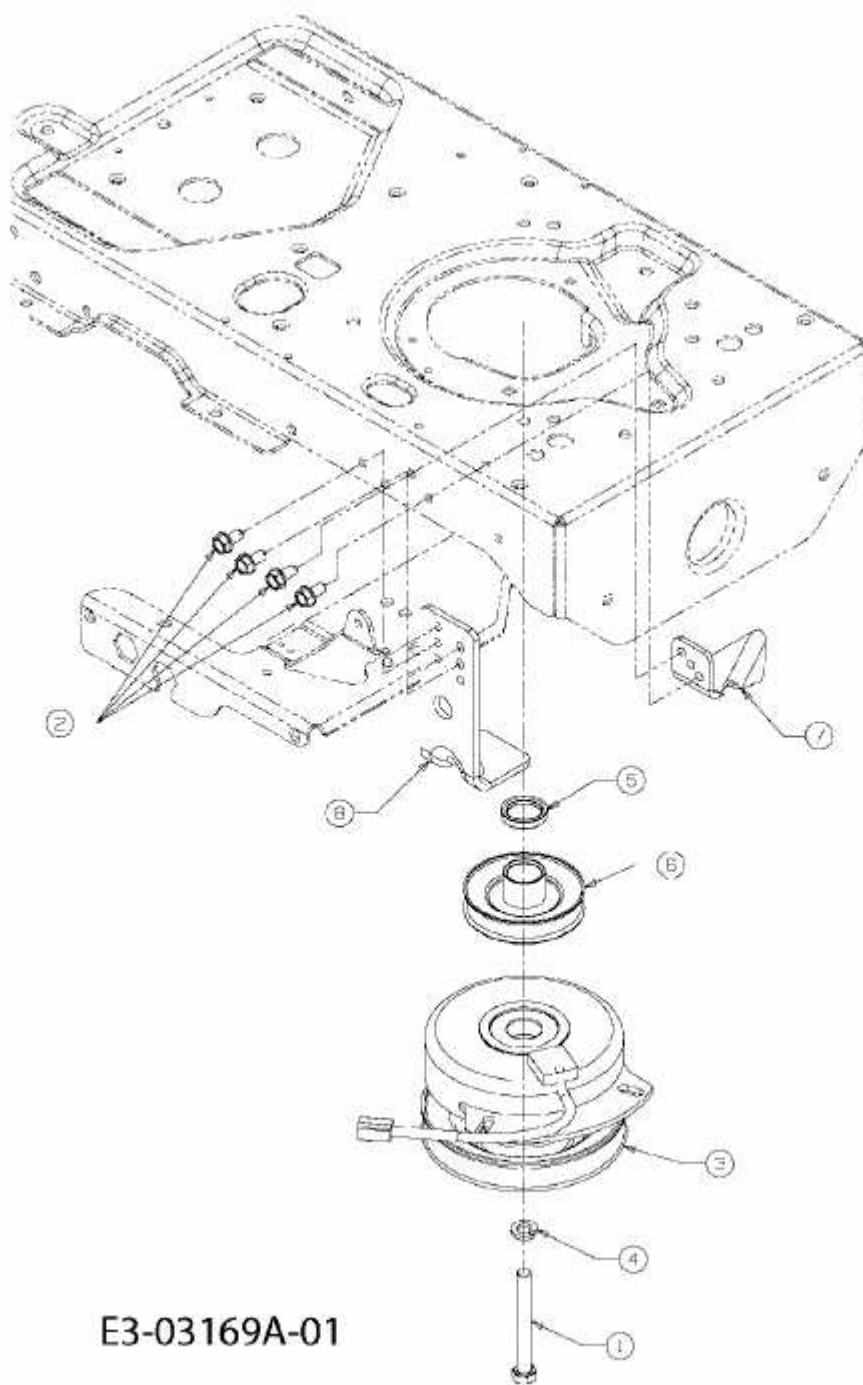

E3-03169A-01