

I 1050 > 17AF9BKP709 (2009) > RAHMEN

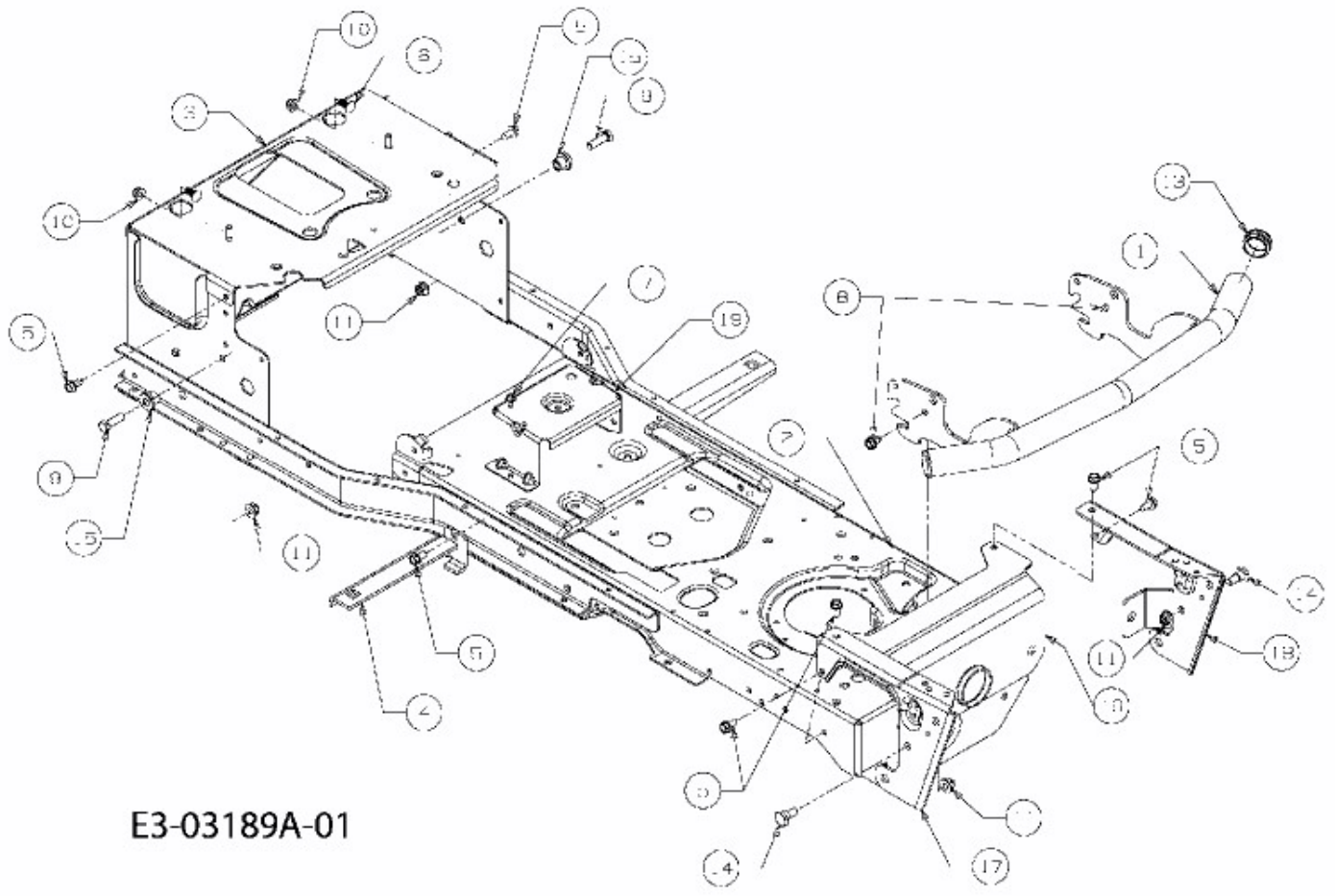

E3-03189A-01