

I 1050 > 17AF9BKP709 (2009) > LENKUNG

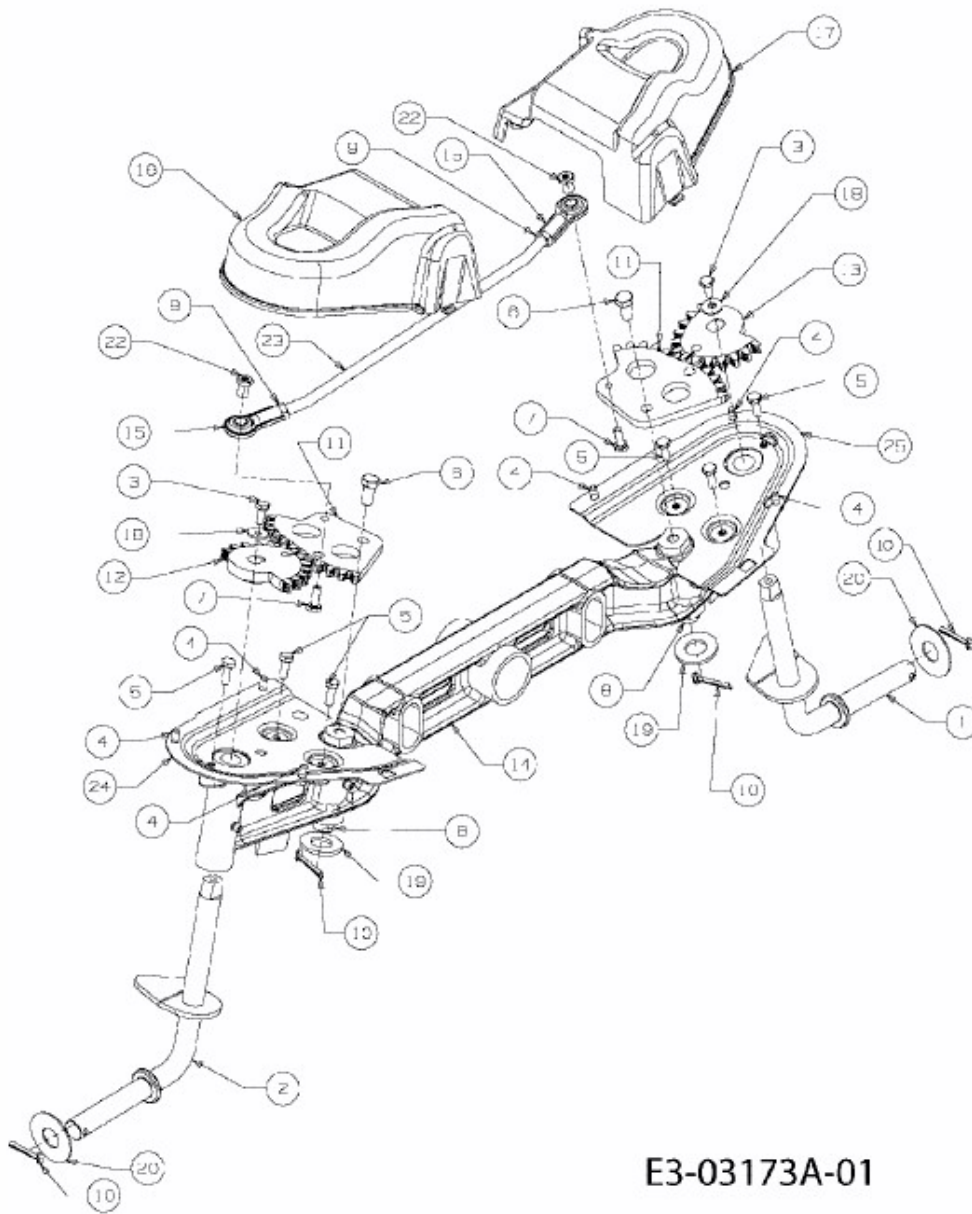

E3-03173A-01