

I 1050 > 17AF9BKP709 (2009) > SITZWANNE

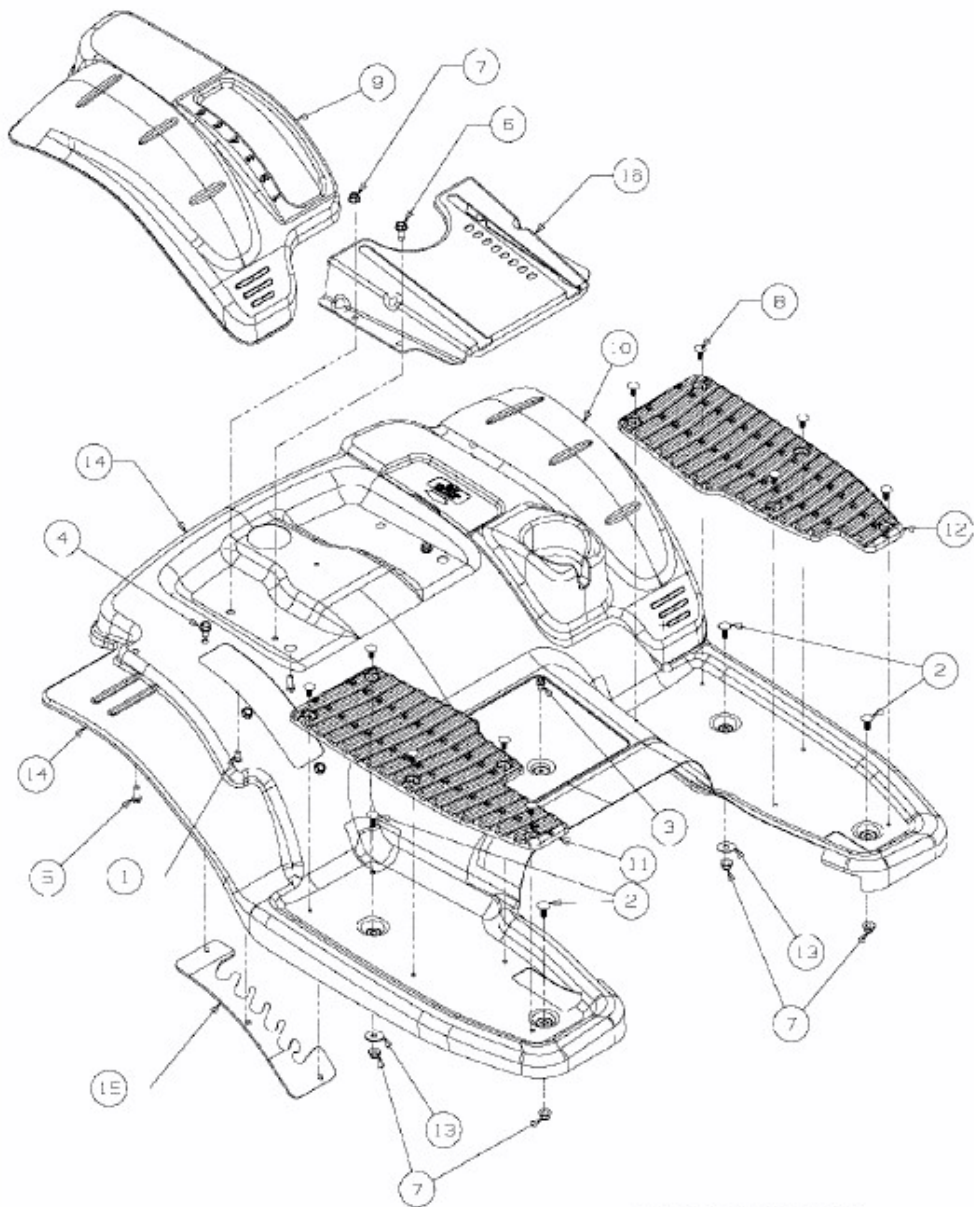

E3-03170A-01