

I 1050 > 17AF9BKP709 (2009) > ELEKTROMAGNETKUPPLUNG, MOTORKEILRIEMENSCHLEIFE

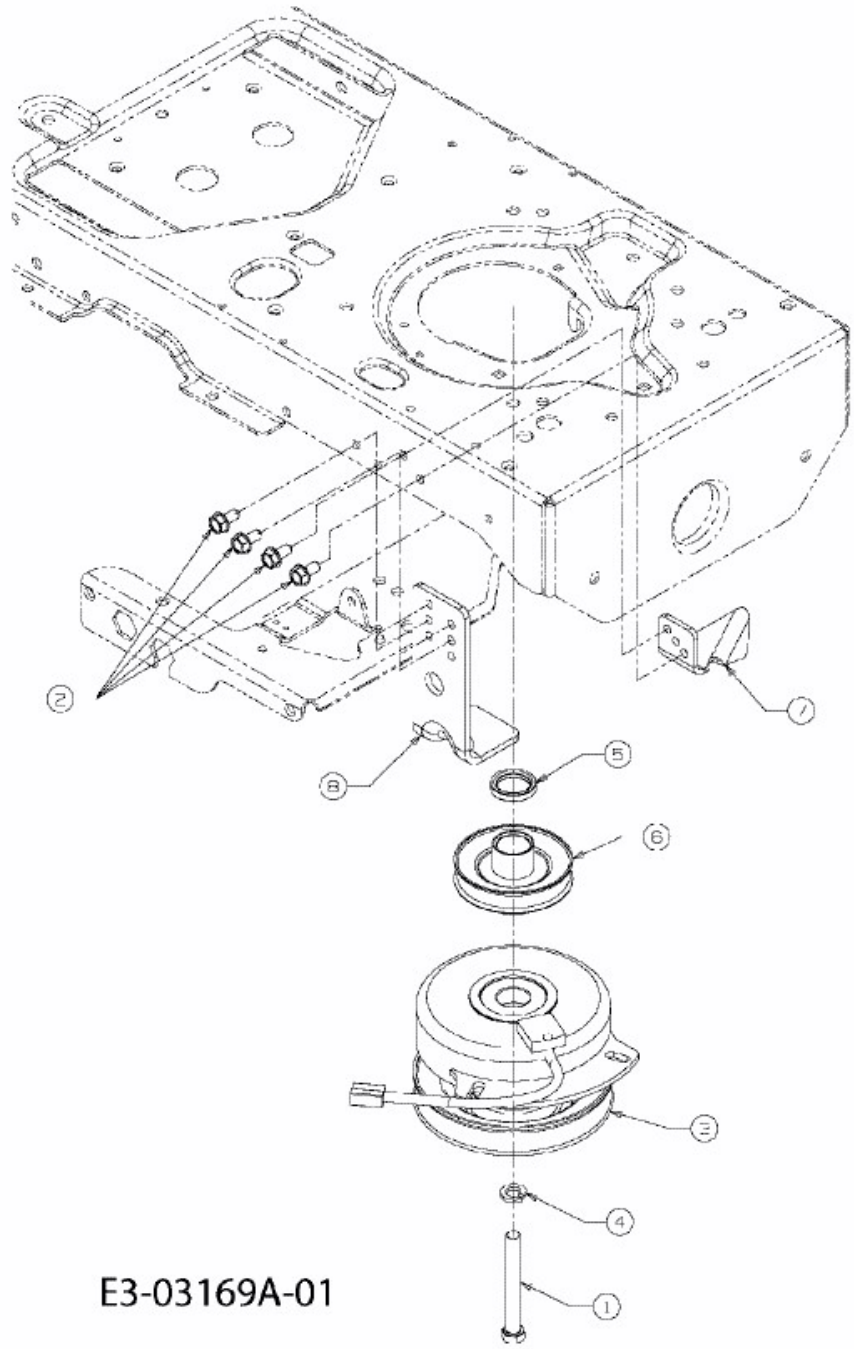

E3-03169A-01