

I 1050 > 17AF9BKP330 (2012) > SITZTRÄGER

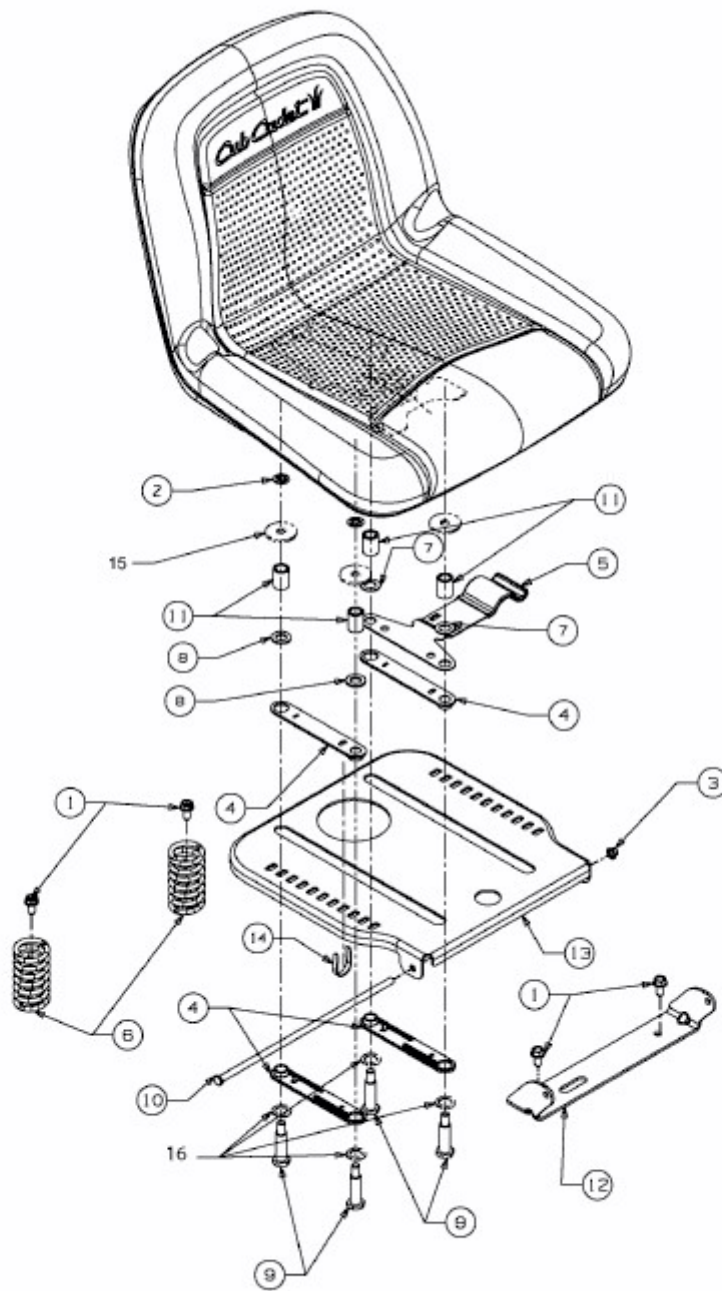

E3-04290B-01