

I 1050 > 17AF9BKP330 (2012) > RAHMEN

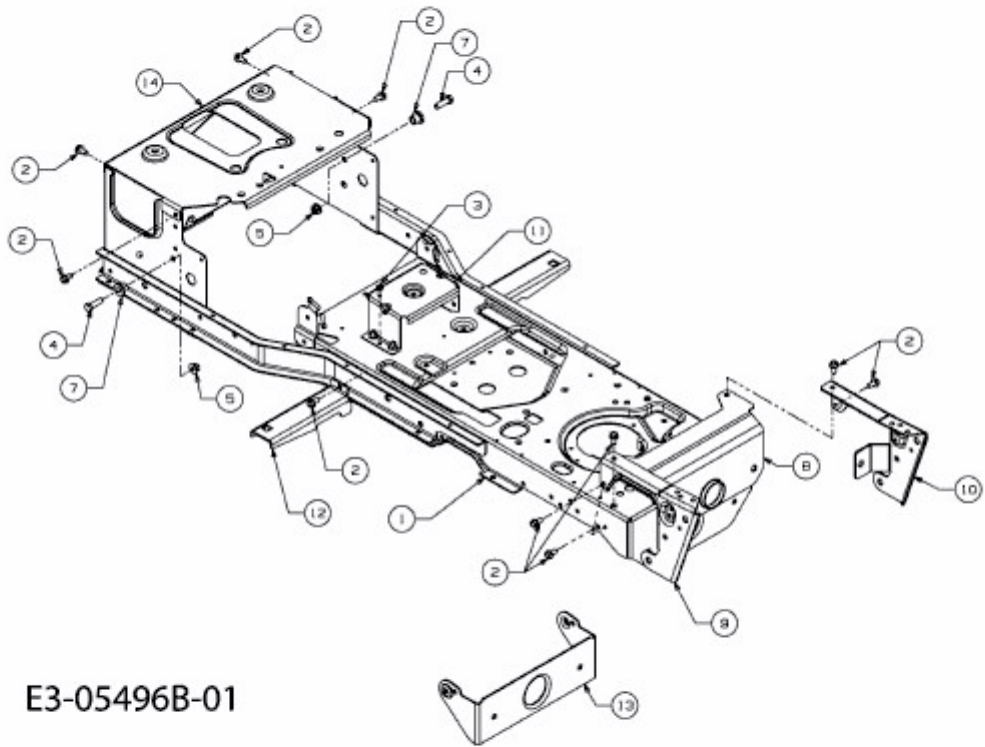

E3-05496B-01