

I 1050 > 17AF9BKP330 (2012) > FAHRANTRIEB

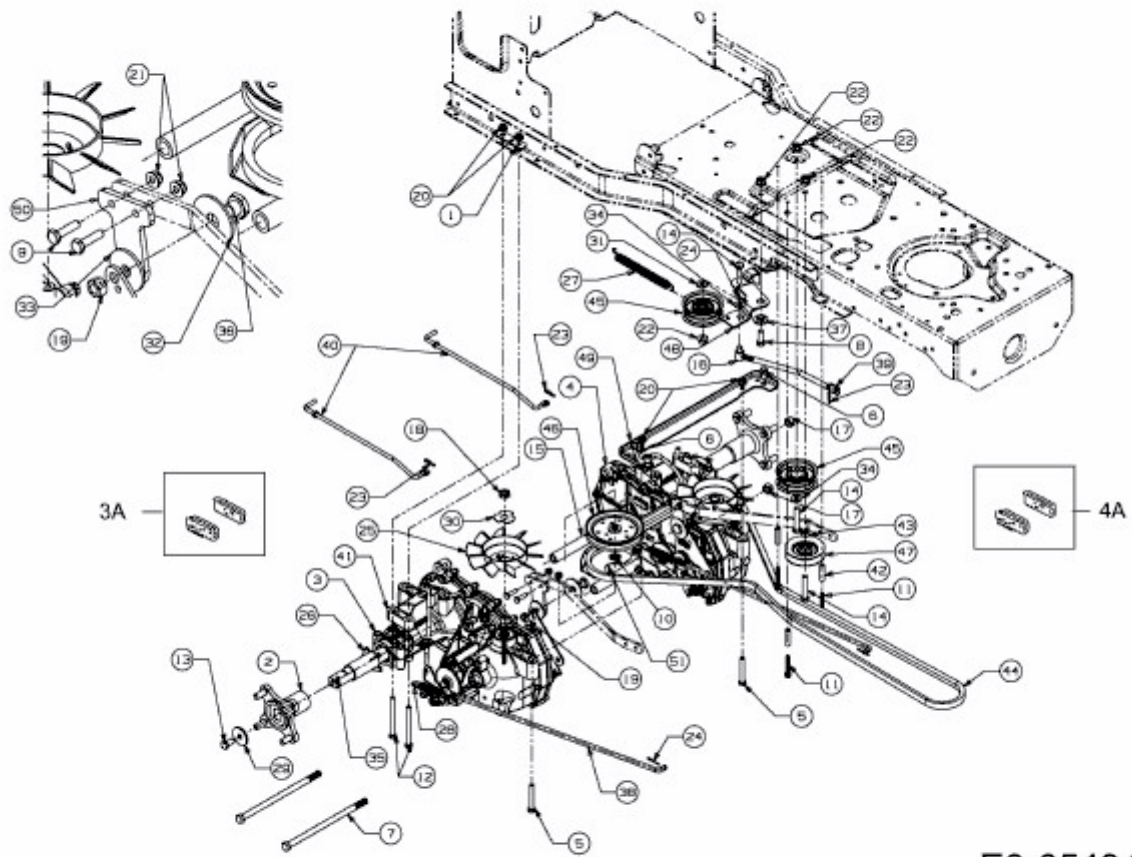

E3-05494B-01