

I 1050 > 17AF9BKP330 (2012) > ELEKTROMAGNETKUPPLUNG, MOTORKEILRIEMENSCHLEIFE

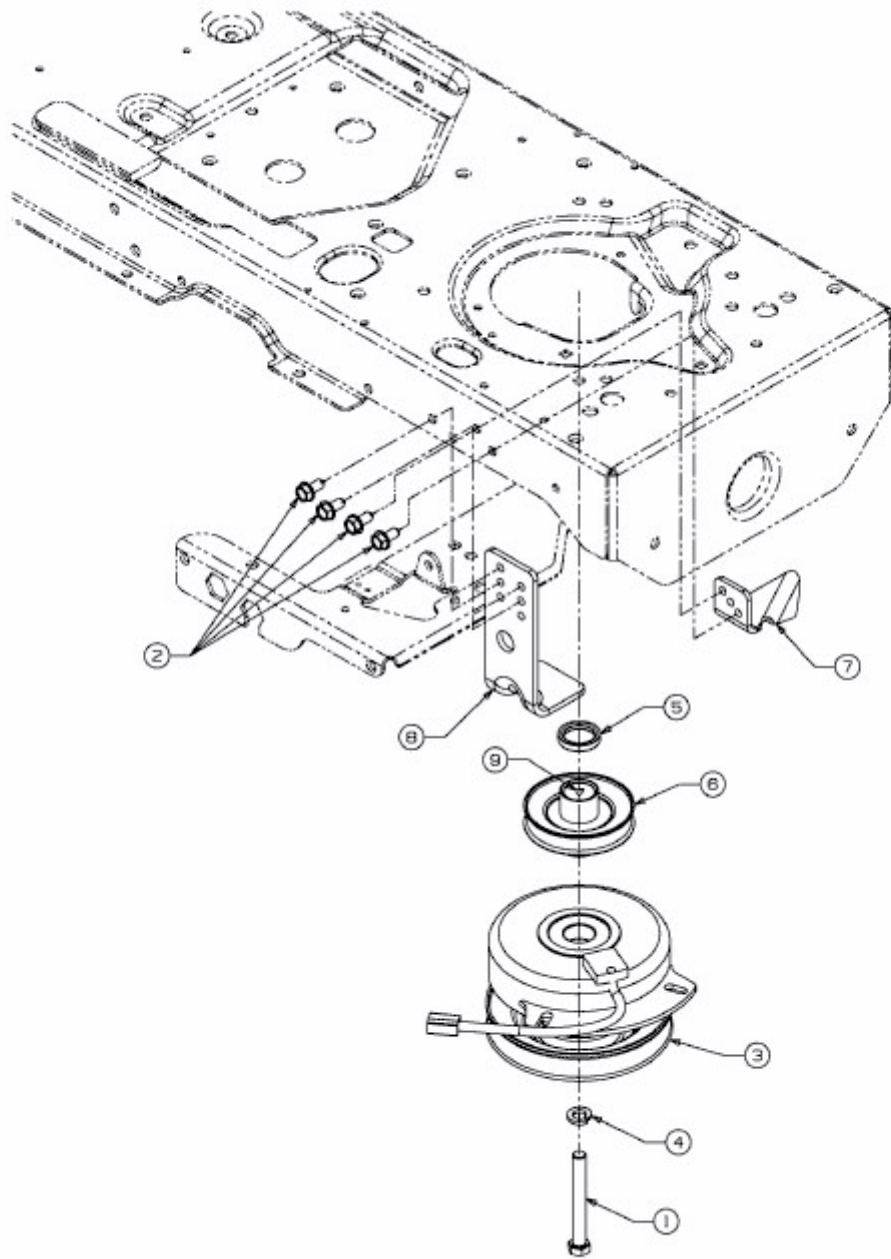

E3-05490A-01