

I 1050 > 17AF9BKP330 (2012) > TANK

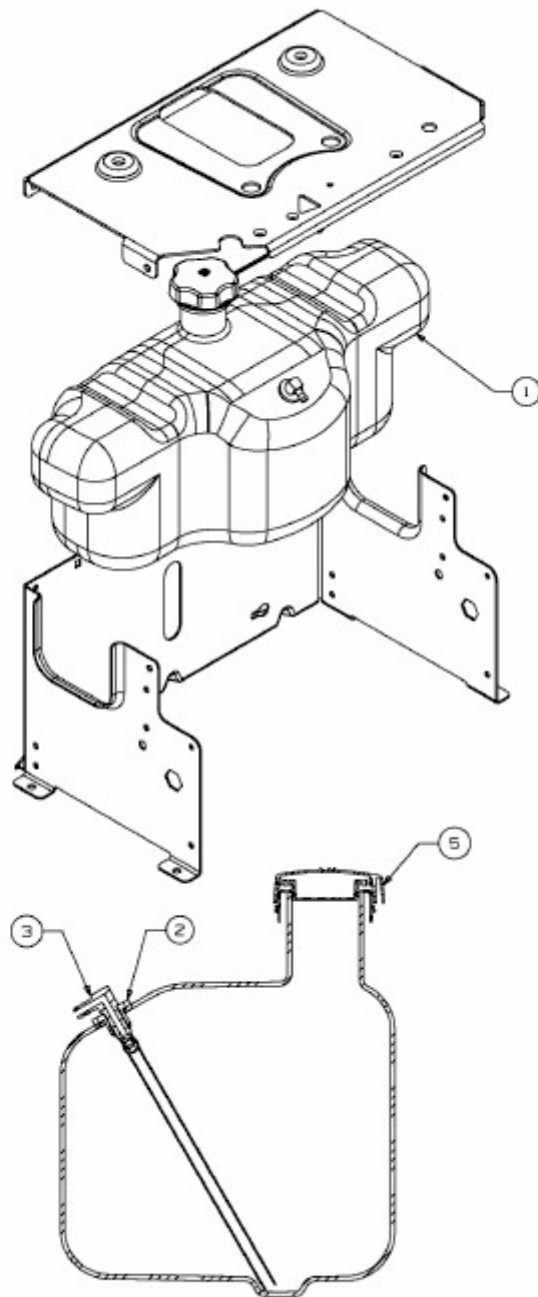

E3-04746A-01