

I 1050 > 17AF9BKP330 (2011) > FAHRANTRIEB

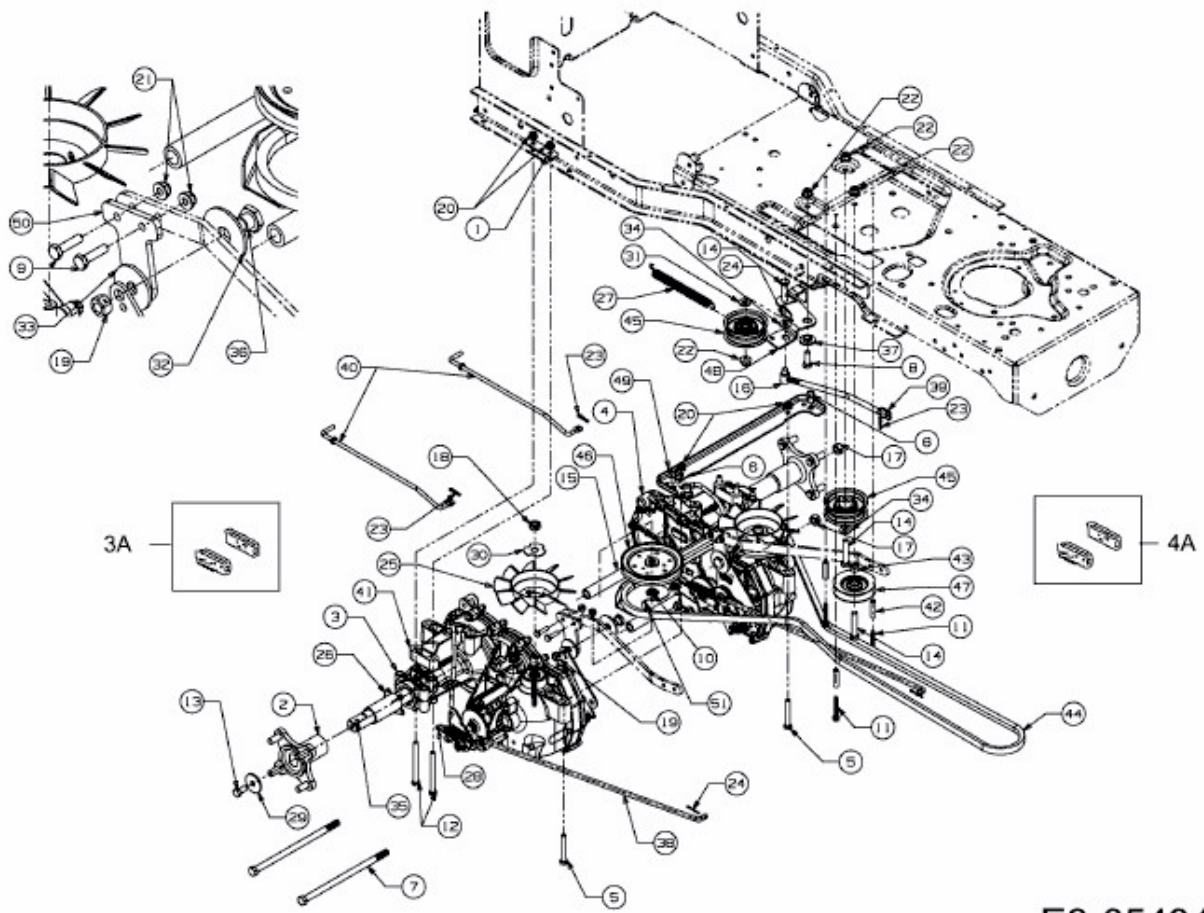

E3-05494B-01