

I 1050 > 17AF9BKP330 (2011) > TANK

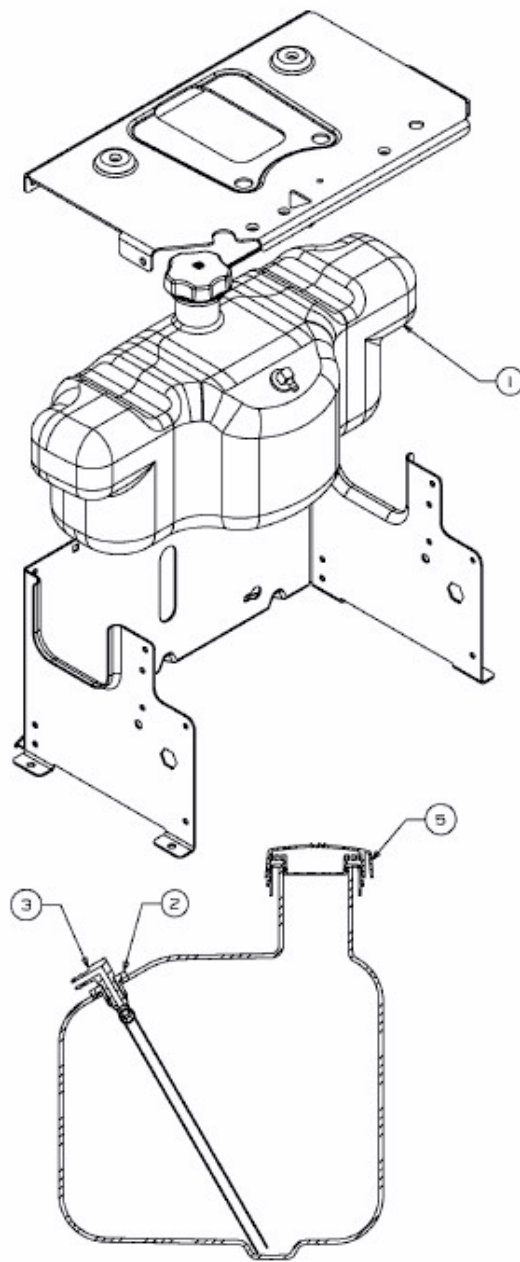

E3-04746A-01