

I 1050 > 17AF9BKP010 (2009) > SITZTRÄGER

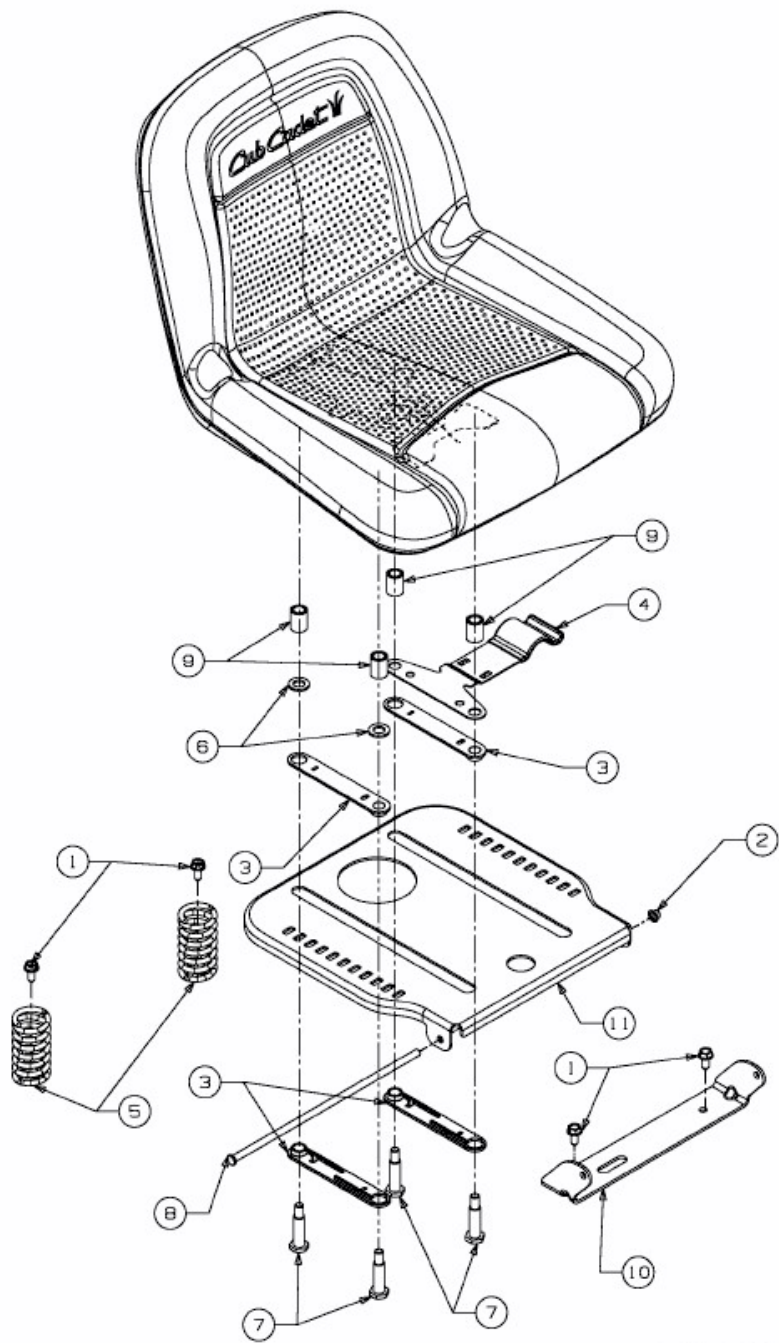

E3-04290A-01