

RZT 42 > 17AE2ACG603 (2009) > RAHMEN, SPANNROLLE FAHRANTRIEB

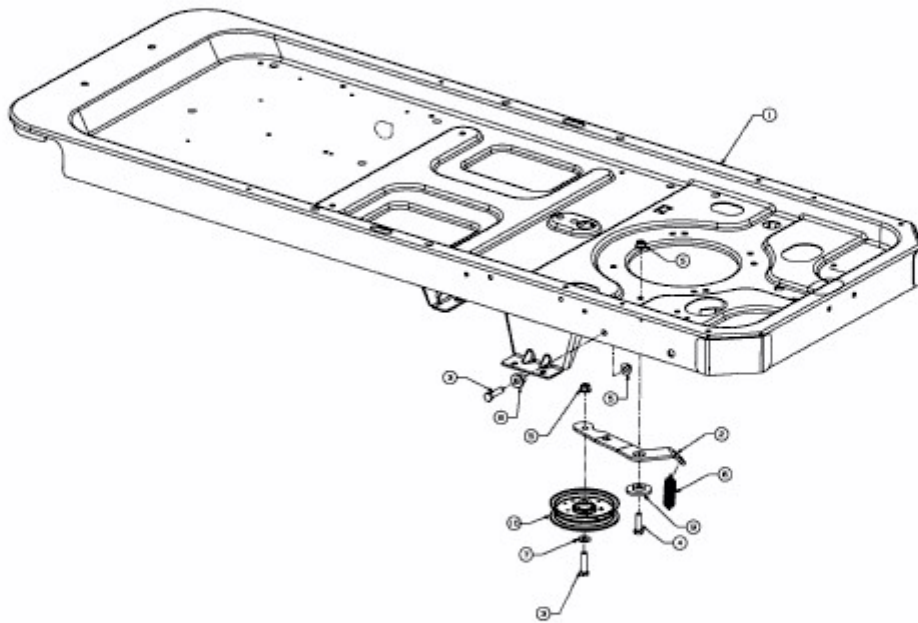

E3-04183A-01