

4035 VG > 16CG5AMQ683 (2011) > VERTIKUTIERERGEHÄUSE

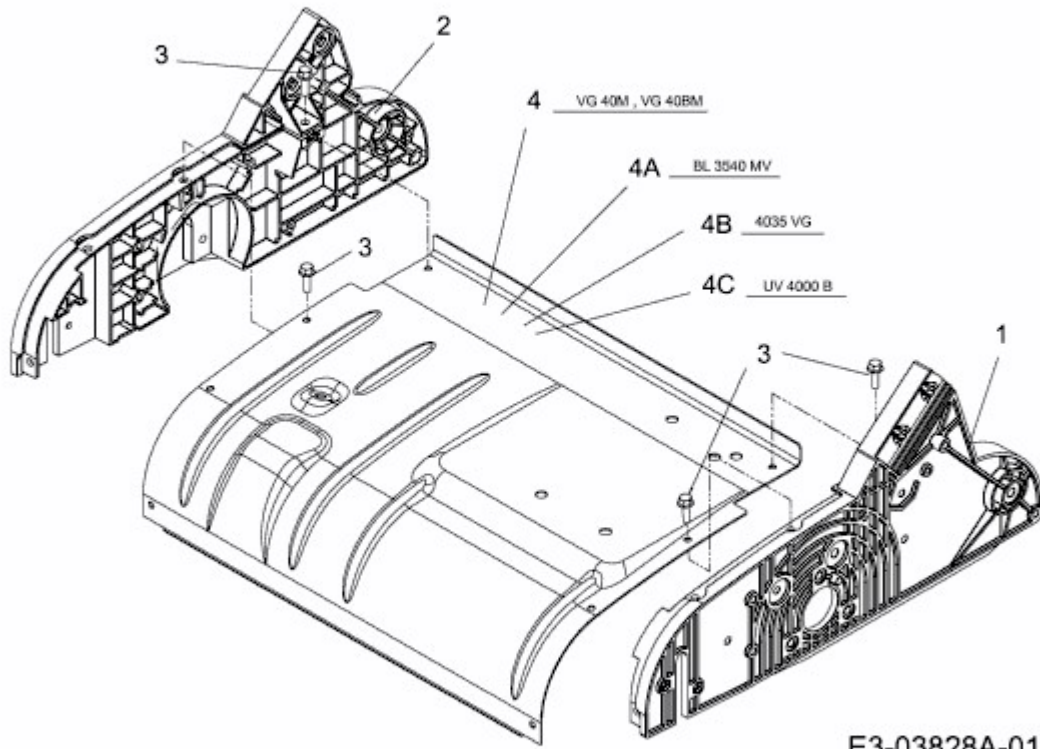

E3-03828A-01