

VS 302 E > 16AFDEKA650 (2016) > GRUNDGERÄT

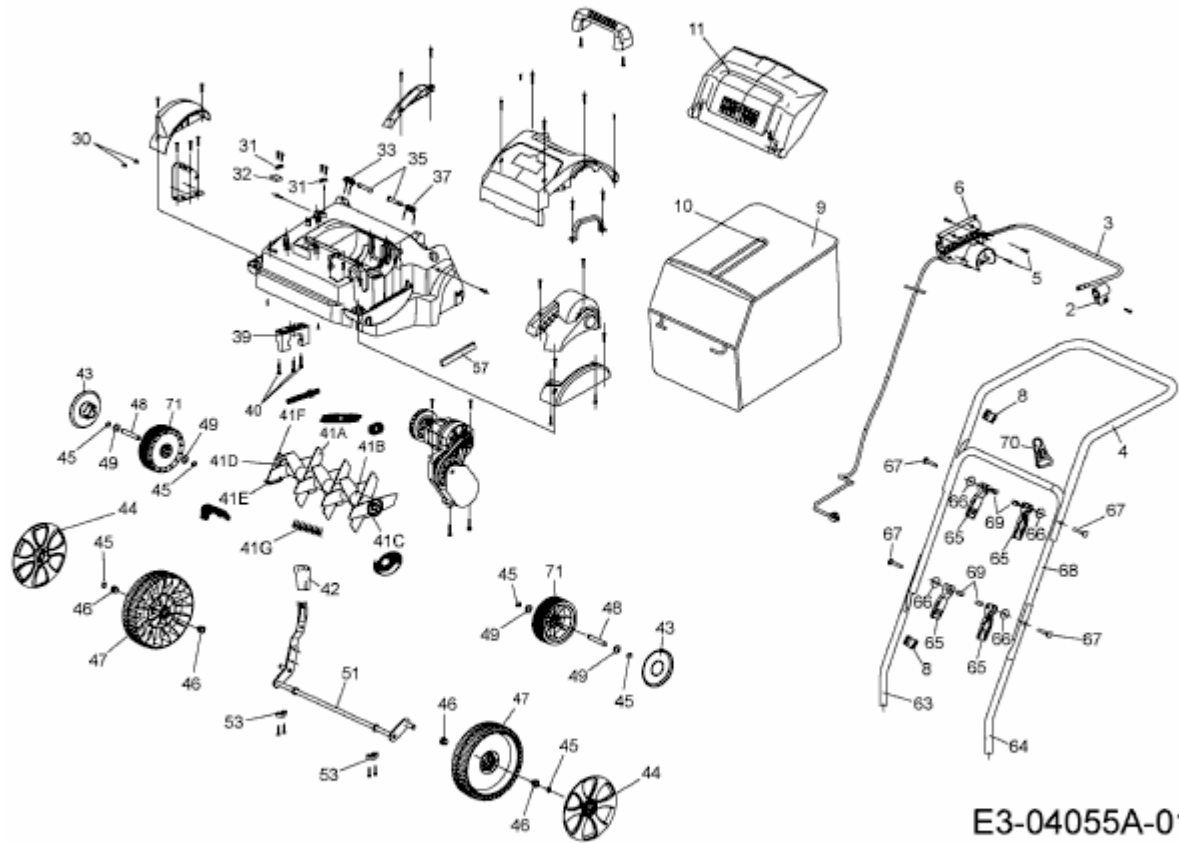

E3-04055A-01