

TT 380 DL > 15A-CD--650 (2016) > GRUNDGERÄT

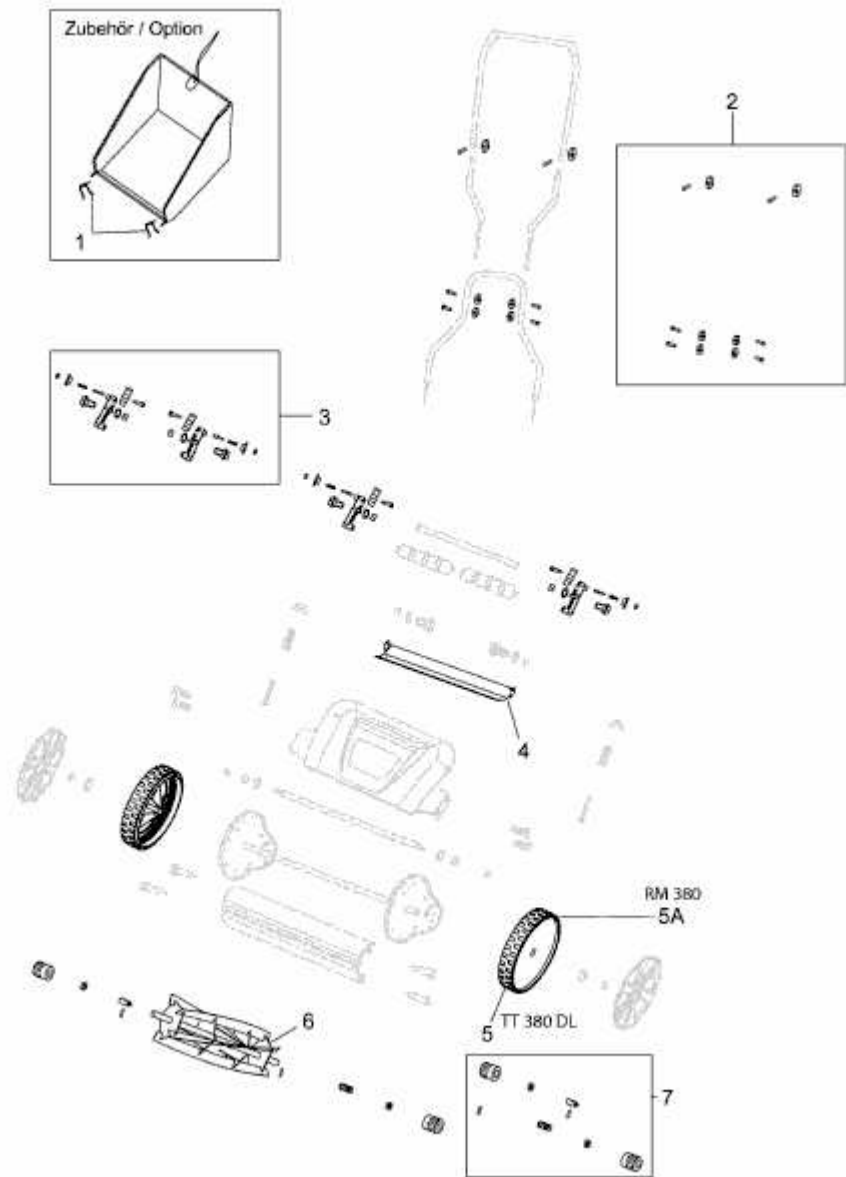

E3-06015B-01