

TT 380 DL > 15A-CD--650 (2014) > GRUNDGERÄT

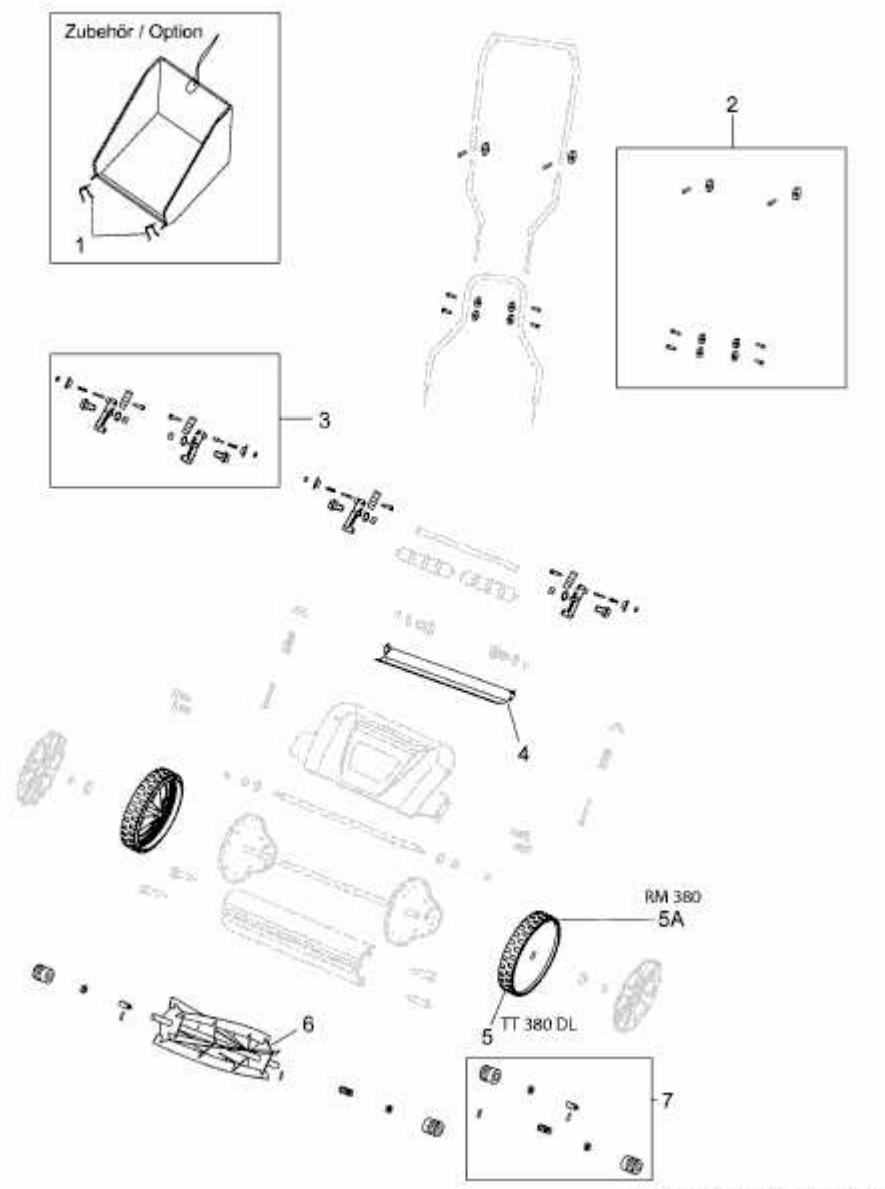

E3-06015B-01